

P-Channel Enhancement Mode MOSFET

Feature

- -40V/-70A
 $R_{DS(ON)} = 5.8\text{ m } (\text{typ.}) @ V_{GS} = -10\text{V}$
 $R_{DS(ON)} = 8.5\text{ m } (\text{typ.}) @ V_{GS} = -4.5\text{V}$
- 100% avalanche tested
- Reliable and Rugged
- Halogen Free and Green Devices Available (RoHS Compliant)

Pin Description

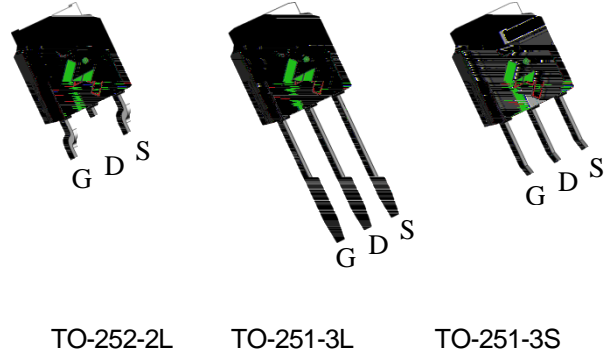

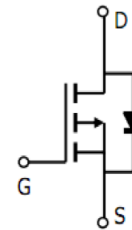

Applications

- Switching application
- Power Management in DC/DC converter.
- Battery protection



P-Channel MOSFET

Ordering and Marking Information

<div style="display: flex; justify-content: space-around;"> <div style="text-align: center;">  D G060P04 XYMXXXXX </div> <div style="text-align: center;">  U G060P04 XYMXXXXX </div> <div style="text-align: center;">  V G060P04 XYMXXXXX </div> </div>	<p>Package Code D: TO-252-2L U: TO-251-3L V: TO-251-3S</p> <p>Date Code XYMXXXXX</p>
---	--

Note: HUAYI lead-free products contain molding compounds/die attach materials and 100% matte tin plate Termination finish; which are fully compliant with RoHS. HUAYI lead-free products meet or exceed the lead-free requirements of IPC/JEDEC J-STD-020 for MSL classification at lead-free peak reflow temperature. HUAYI defines Green to mean lead-free (RoHS compliant) and halogen free (Br or Cl does not exceed 900ppm by weight in homogeneous material and total of Br and Cl does not exceed 1500ppm by weight).

HUAYI reserves the right to make changes to improve reliability or manufacturability without notice, and Advise customers to obtain the latest version of relevant information to verify before placing orders.

Absolute Maximum Ratings

Symbol	Parameter		Rating	Unit
Common Ratings (Tc=25°C Unless Otherwise Noted)				
V _{DSS}	Drain-Source Voltage		-40	V
V _{GSS}	Gate-Source Voltage		±20	V
T _J	Junction Temperature Range		-55 to 175	°C
T _{STG}	Storage Temperature Range		-55 to 175	°C
I _S	Drain Current-Continuous	Tc=25°C	-70	A
Mounted on Large Heat Sink				
I _{DM}	Pulsed Drain Current *	Tc=25°C	-280	A
I _D	Continuous Drain Current	Tc=25°C	-70	A
		Tc=100°C	-49.5	A
P _D	Maximum Power Dissipation	Tc=25°C	65	W
		Tc=100°C	32.5	W
R _{θJC}	Thermal Resistance, Junction-to-Case		2.3	°C/W
R _{θJA}	Thermal Resistance, Junction-to-Ambient **		110	°C/W
E _{AS}	SinglePulsed-Avalanche Energy ***	L=0.3mH	309***	mJ

Note: * Repetitive rating; pulse width limited by max junction temperature.
 ** Surface mounted on FR-4 board.
 *** Limited by T_{Jmax} , starting T_J=25°C, L = 0.3mH, R_G= 25 , V_{GS}= -10V.

Electrical Characteristics(Tc =25°C Unless Otherwise Noted)

Symbol	Parameter	Test Conditions	HYG060P04LQ1			Unit
			Min	Typ	Max	
Static Characteristics						
BV _{DSS}	Drain-Source Breakdown Voltage	V _{GS} =0V, I _{DS} =-250uA	-40	-	-	V
I _{DSS}	Drain-to-Source Leakage Current	V _{DS} =-40V, V _{GS} =0V	-	-	-1	uA
		T _J =125°C	-	-	-50	uA
V _{GS(th)}	Gate Threshold Voltage	V _{DS} =V _{GS} , I _{DS} =-250uA	-1.0	-1.6	-3.0	V
I _{GSS}	Gate-Source Leakage Current	V _{GS} = 20V, V _{DS} =0V	-	-	±100	nA
R _{DS(ON)*}	Drain-Source On-state Resistance	V _{GS} =-10V, I _D = -20A	-	5.8	7.5	m
		V _{GS} =-4.5V, I _D = -20A		8.5	10.5	m
Diode Characteristics						
V _{SD*}	Diode Forward Voltage	I _{SD} = -20A, V _{GS} =0V	-	-0.82	-1.3	V
t _{rr}	Reverse Recovery Time	I _{SD} = -20				

Electrical Characteristics (Cont.) (T_c =25°C Unless Otherwise Noted)

Symbol	Parameter	Test Conditions	HYG060P04LQ1			Unit
			Min	Typ	Max	
Dynamic Characteristics						
R _G	Gate Resistance	V _{GS} =0V, V _{DS} =0V, F=1MHz	-	4.8	-	
C _{iss}	Input Capacitance	V _{GS} =0V, V _{DS} =-25V, Frequency=1.0MHz	-	6774	-	pF
C _{oss}	Output Capacitance		-	431	-	
C _{rss}	Reverse Transfer Capacitance		-	403	-	
t _{d(ON)}	Turn-on Delay Time	V _{DD} = -20V, R _G =2.5 I _{DS} = -20A, V _{GS} =-10V	-	12	-	ns
T _r	Turn-on Rise Time		-	47	-	
t _{d(OFF)}	Turn-off Delay Time		-	128	-	
T _f	Turn-off Fall Time		-	68	-	
Gate Charge Characteristics						
Q _g	Total Gate Charge (V _{GS} = -10V)	V _{DS} = -32V, I _D = -20A,		128		nC
Q _g	Total Gate Charge (V _{GS} = -4.5V)		-	63	-	
Q _{gs}	Gate-Source Charge		-	24	-	
Q _{gd}	Gate-Drain Charge		-	24	-	

Note: *Pulse test; pulse width 300us duty cycle 2%

Typical Operating Characteristics

Figure 1: Power Dissipation

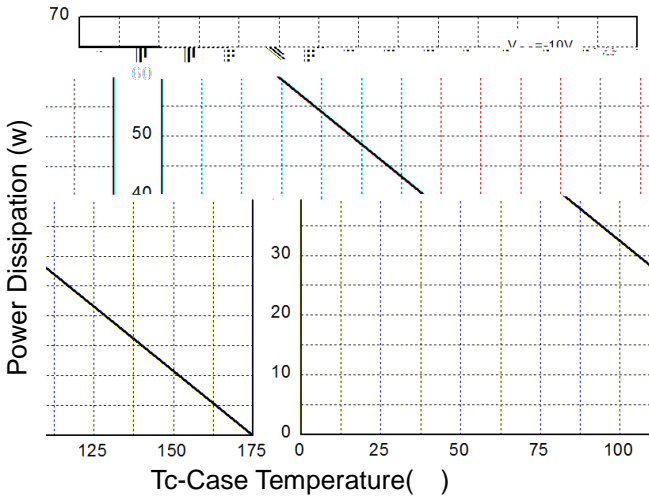

Figure 2: Drain Current

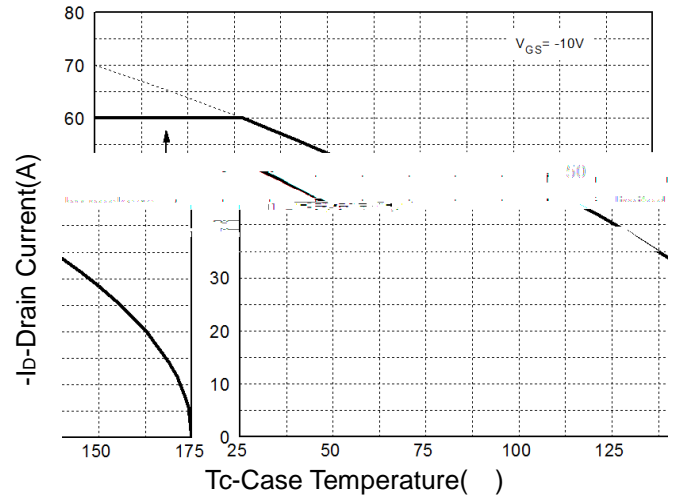

Figure 3: Safe Operation Area

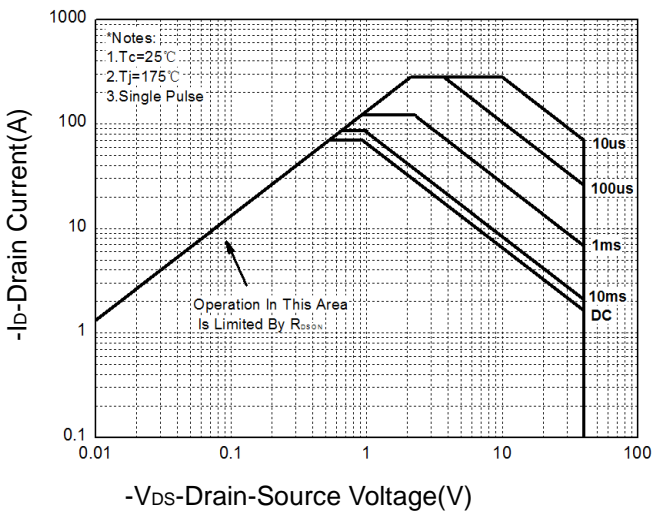

Figure 4: Thermal Transient Impedance

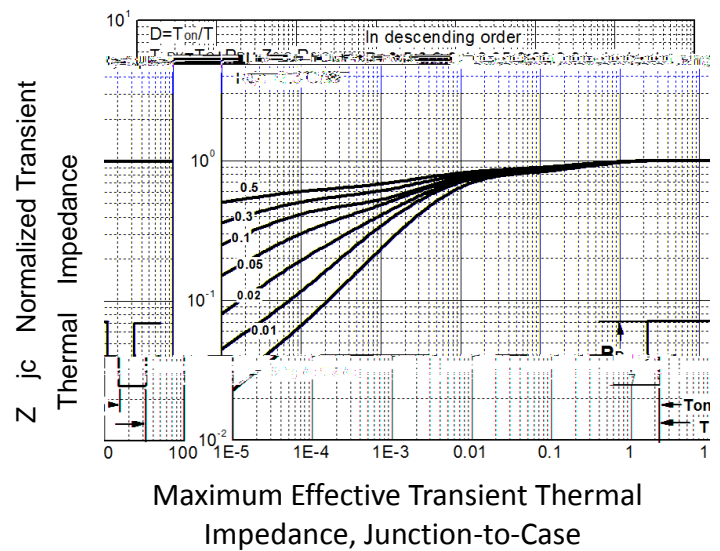

Figure 5: Output Characteristics

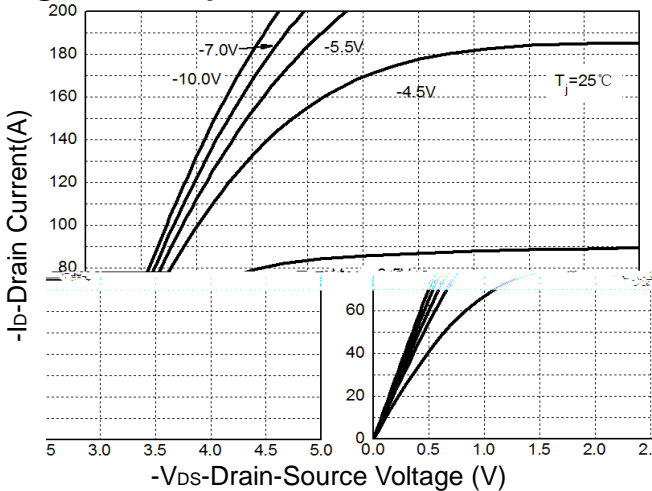
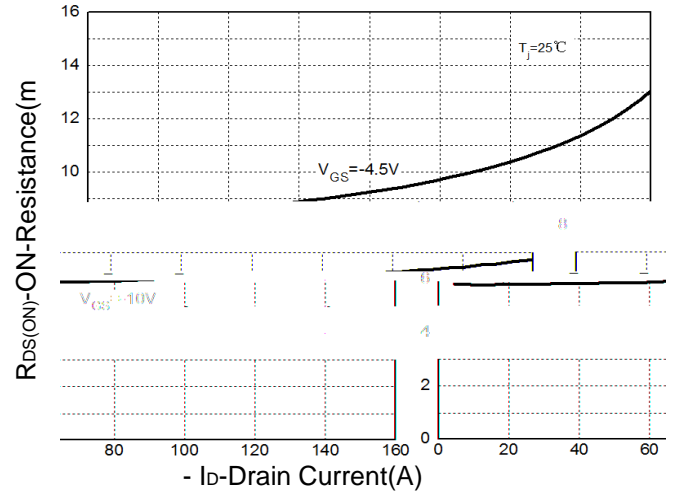

Figure 6: Drain-Source On Resistance



Typical Operating Characteristics(Cont.)

Figure 7: On-Resistance vs. Temperature

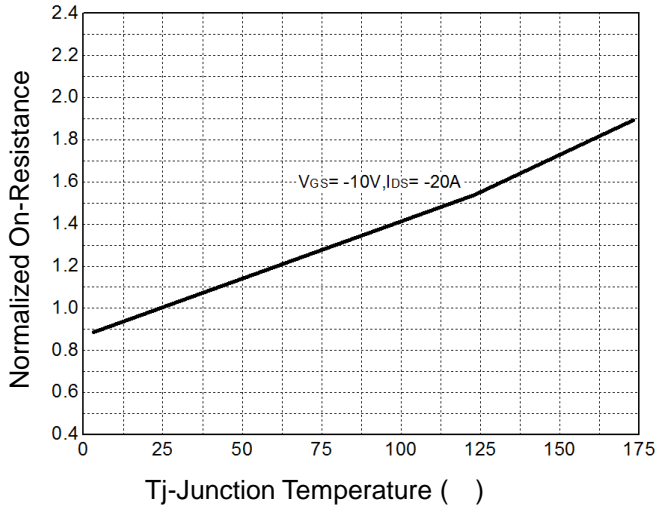

Figure 8: Source-Drain Diode Forward

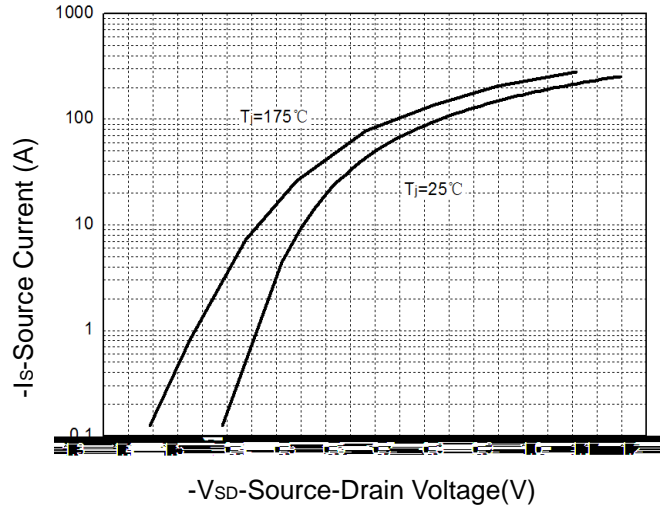

Figure 9: Capacitance Characteristics

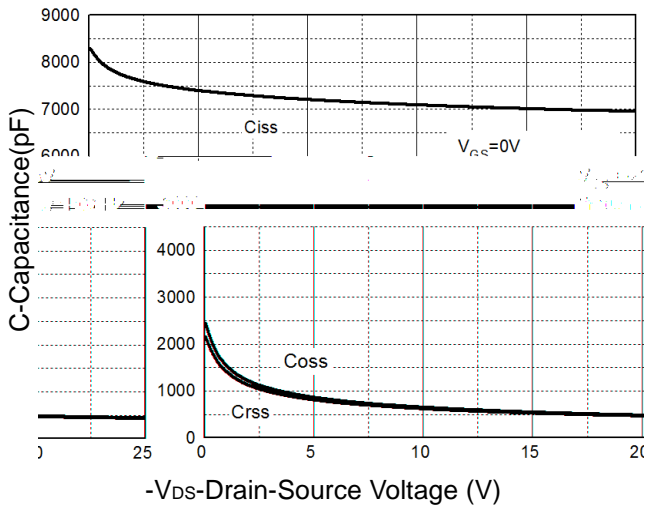
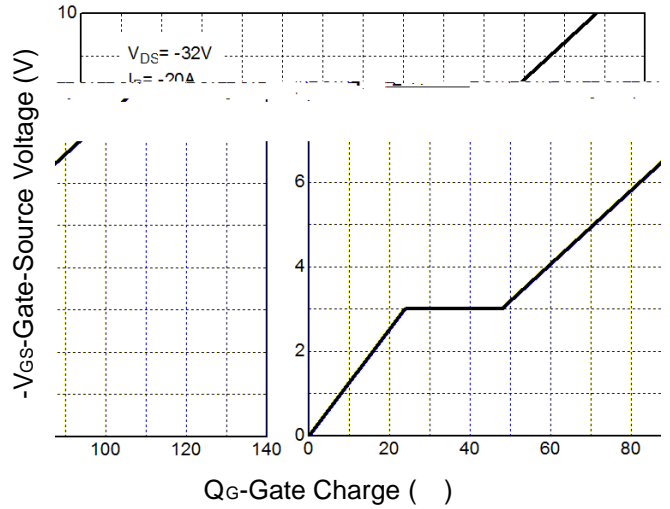
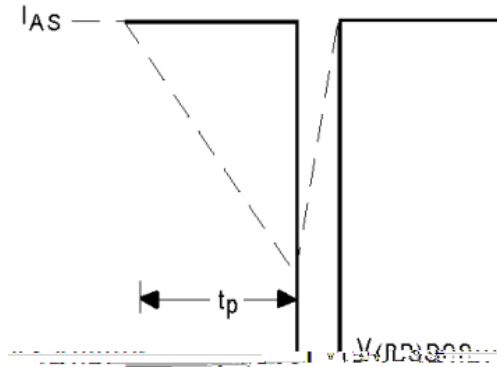
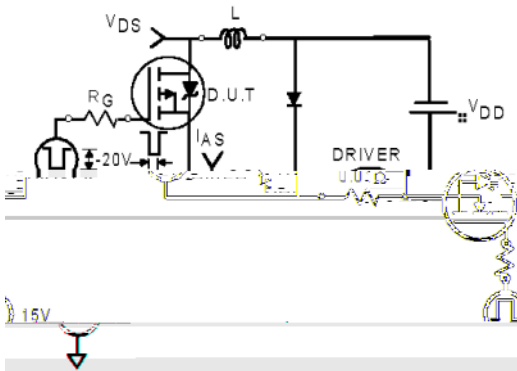

Figure 10: Gate Charge Characteristics



Avalanche Test Circuit



Switching Time Test Circuit

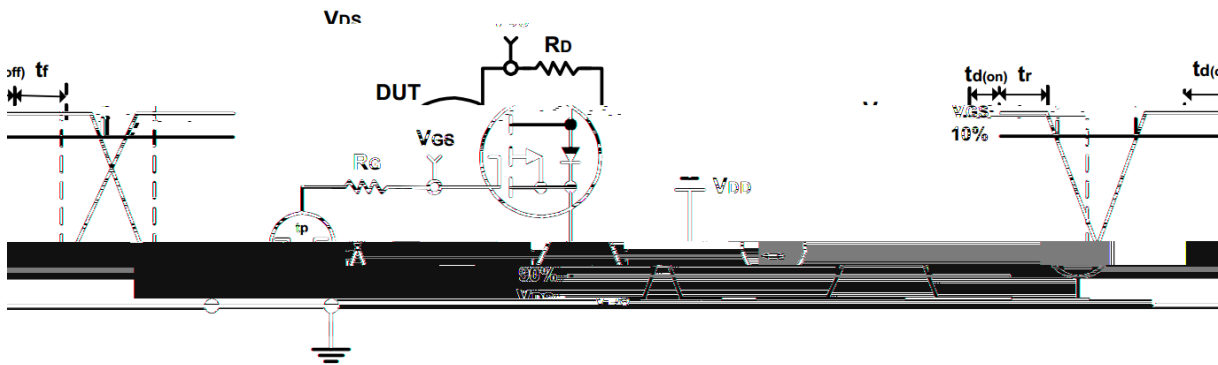

Gate Charge Test Circuit

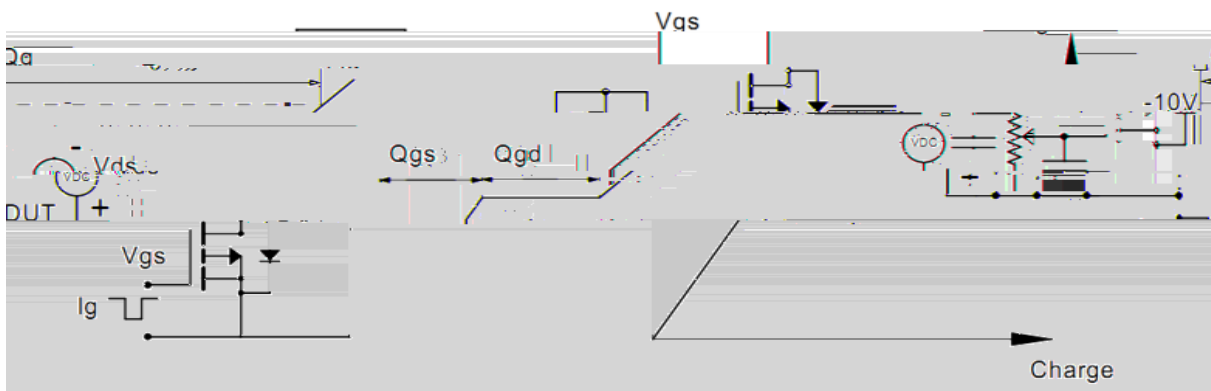

Device Per Unit

Package Type	Unit	Quantity
TO-252-2L	Tube	75
TO-252-2L	Reel	2500
TO-251-3L	Tube	75
TO-251-3S	Tube	75

Package Information

TO-252-2L

COMMON DIMENSIONS

SYMBOL	mm		
	MIN	NOM	MAX
A	2.20	2.30	2.40
A1	0.00	-	0.20
A2	0.97	1.07	1.17
b	0.68	0.78	0.90
b3	5.20	5.33	5.50
c	0.43	0.53	0.63
D	5.98	6.10	6.22
D1	5.30REF		
E	6.40	6.60	6.80
E1	4.63	-	-
e	2.286BSC		
H	9.40	10.10	10.50
L	1.38	1.50	1.75
L1	2.90REF		
L2	0.51BSC		

TO-251-3L

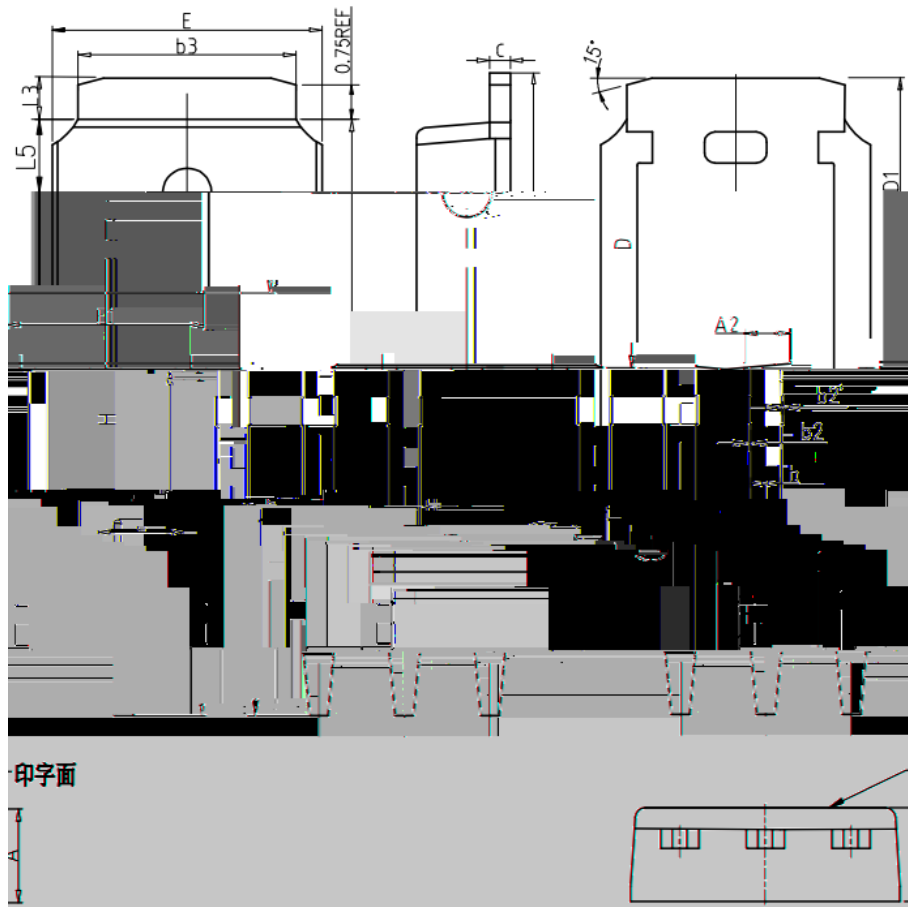

COMMON DIMENSIONS

SYMBOL	mm		
	MIN	NOM	MAX
A	2.20	2.30	2.40
A2	0.97	1.07	1.17
b	0.68	0.78	0.90
b2	0.00	0.04	0.10
b2'	0.00	0.04	0.10
b3	5.20	5.33	5.50
c	0.43	0.53	0.63
D	5.98	6.10	6.22
D1	5.30REF		
E	6.40	6.60	6.80
E1	4.63	-	-
e	2.286BSC		
H	16.22	16.52	16.82
L1	9.15	9.40	9.65
L3	0.88	1.02	1.28
L5	1.65	1.80	1.95

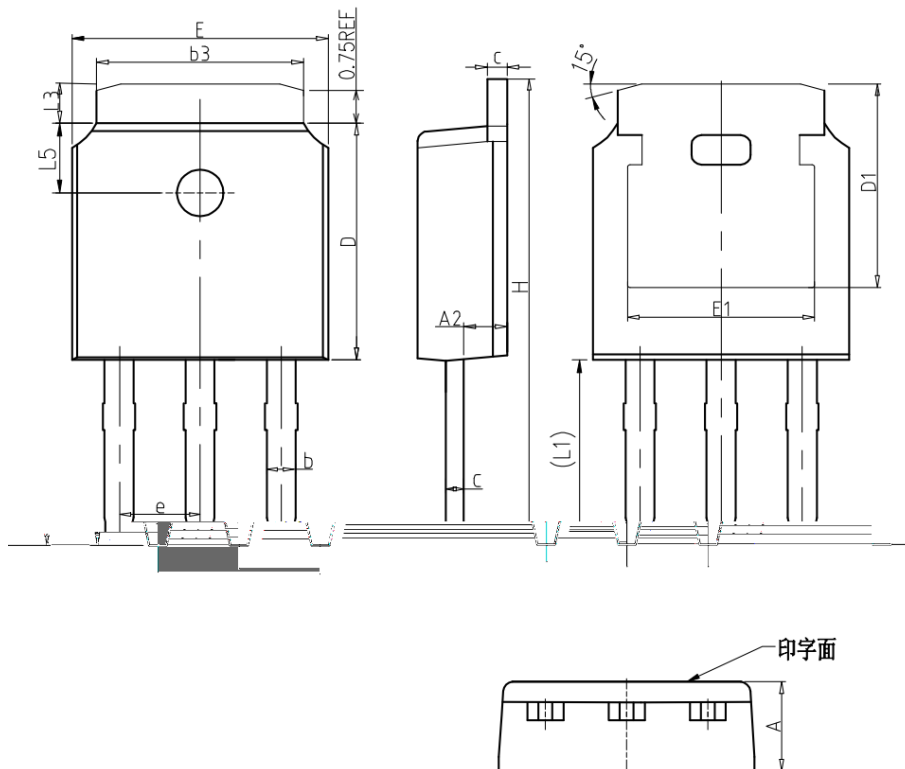

COMMON DIMENSIONS

SYMBOL	mm		
	MIN	NOM	MAX
A	2.20	2.30	2.40
A2	0.97	1.07	1.17
b	0.68	0.78	0.90
b3	5.20	5.33	5.50
c	0.43	0.53	0.63
D	5.98	6.10	6.22
D1	5.30REF		
E	6.40	6.60	6.80
E1	4.63	-	-
e	2.286BSC		
H	10.00	11.22	11.44
L1	3.90	4.10	4.30
L3	0.88	1.02	1.28
L5	1.65	1.80	1.95

Classification Profile

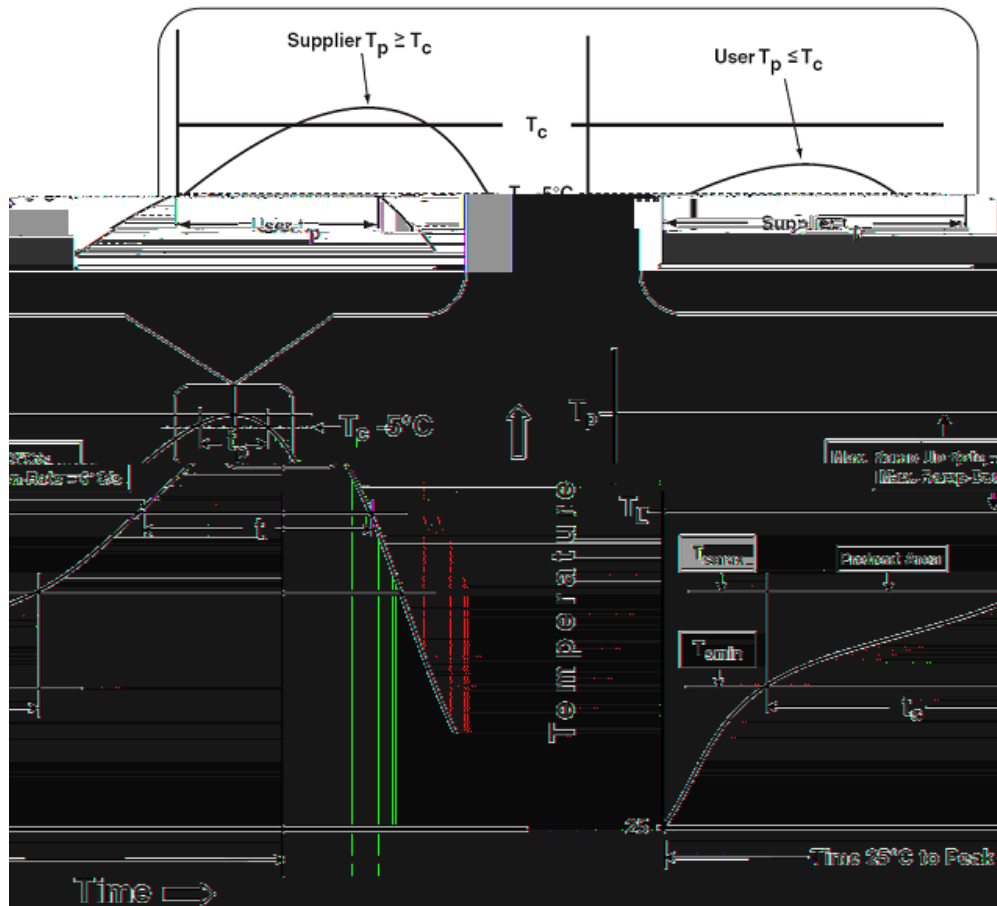

Classification Reflow Profiles

Profile Feature	Sn-Pb Eutectic Assembly	Pb-Free Assembly
Preheat & Soak		
Temperature min (T_{smin})	100 °C	150 °C
Temperature max (T_{smax})	150 °C	200 °C
Time (T_{smin} to T_{smax}) (t_s)	60-120 seconds	60-120 seconds
Average ramp-up rate (T_{smax} to T_p)	3 °C/second max.	3°C/second max.
Liquidous temperature (T_L)	183 °C	217 °C
Time at liquidous (t_L)	60-150 seconds	60-150 seconds
Peak package body Temperature (T_p)*	See Classification Temp in table 1	See Classification Temp in table 2
Time (t_p)** within 5°C of the specified classification temperature (T_c)	20** seconds	30** seconds
Average ramp-down rate (T_p to T_{smax})	6 °C/second max.	6 °C/second max.
Time 25°C to peak temperature	6 minutes max.	8 minutes max.
*Tolerance for peak profile Temperature (T_p) is defined as a supplier minimum and a user maximum.		
** Tolerance for time at peak profile temperature (t_p) is defined as a supplier minimum and a user maximum.		

Table 1. SnPb Eutectic Process Classification Temperatures (Tc)

Package Thickness	Volume mm <350	Volume mm 350
2.5 mm	235 °C	220 °C
	220 °C	220 °C

Table 2. Pb-free Process Classification Temperatures (Tc)

Package Thickness	Volume mm <350	Volume mm 350-2000	Volume mm 2000
<1.6 mm	260 °C	260 °C	260 °C
1.6 mm 2.5 mm	260 °C	250 °C	245 °C
2.5 mm	250 °C	245 °C	245 °C

Reliability Test Program

Test item	Method	Description
SOLDERABILITY	JESD-22, B102	5 Sec, 245°C
HTGB	JESD-22, A108	168/500/1000 Hrs, Bias @ 150°C
HTRB	JESD-22, A108	168/500/1000 Hrs, Bias @ 150°C
PCT	JESD-22, A102	96 Hrs, 100%RH, 2atm, 121°C
TCT	JESD-22, A104	500 Cycles, -55°C~150°C

Customer Service

Worldwide Sales and Service: sales@hymexa.com

Technical Support: Technology@hymexa.com

Huayi Microelectronics Co., Ltd.

No.8928, Shangji Road, Economic and Technological Development Zone, Xi'an, China

TEL: (86-029) 86685706

FAX: (86-029) 86685705

E-mail: sales@hymexa.com

Web net: www.hymexa.com