

--

•

•

•

•

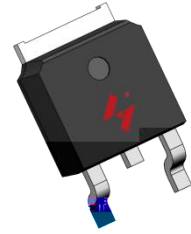

•

•

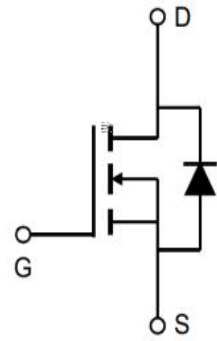

	
---	--



( .)

				0 0 1			
					.		

È

1

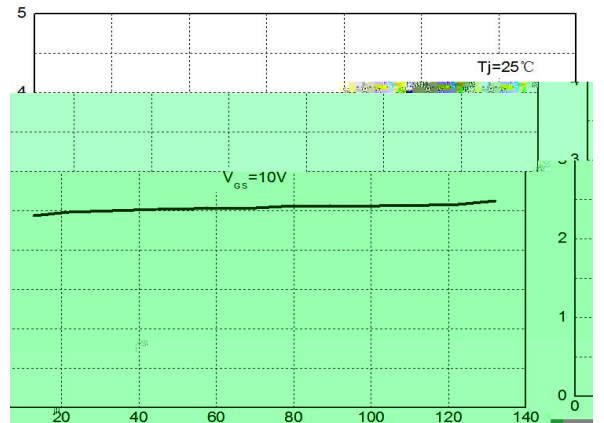
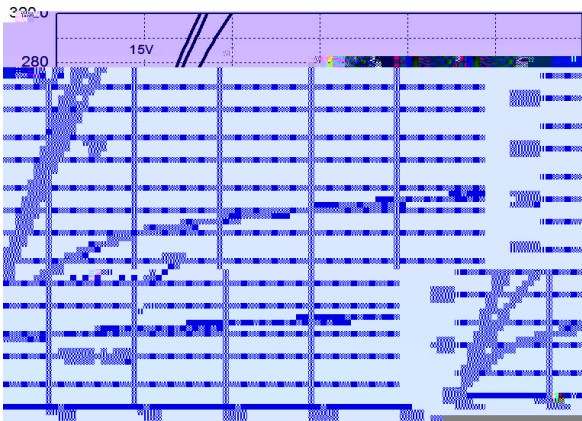
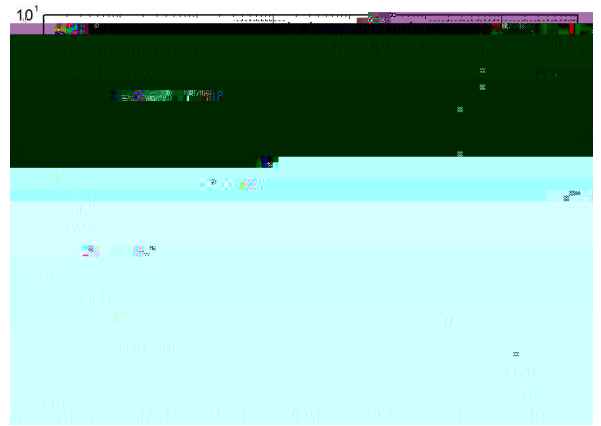
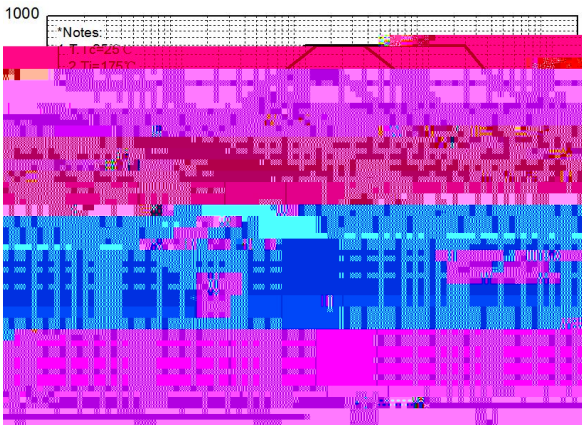
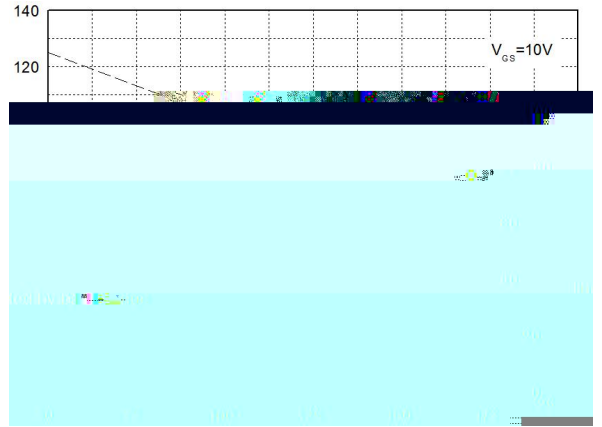
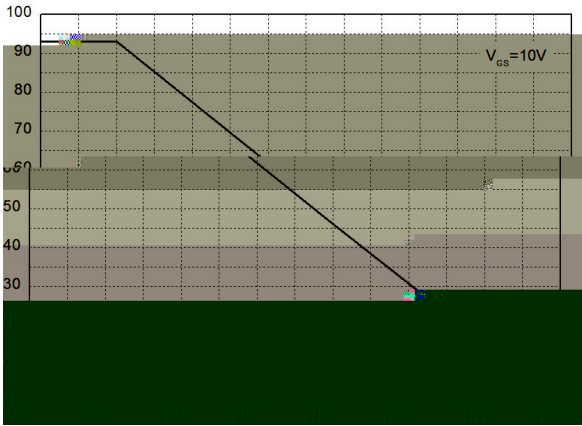

( .)

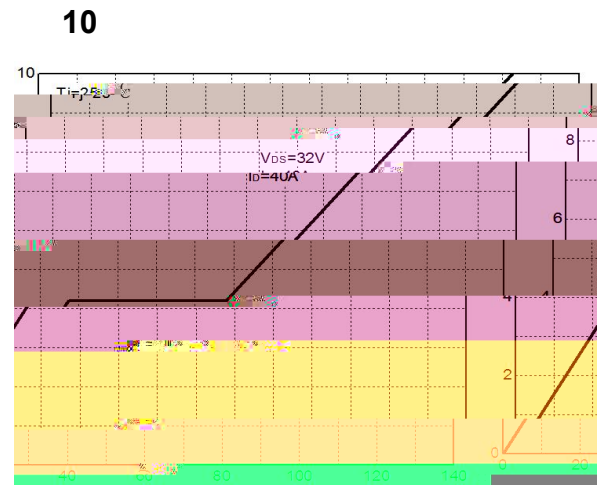
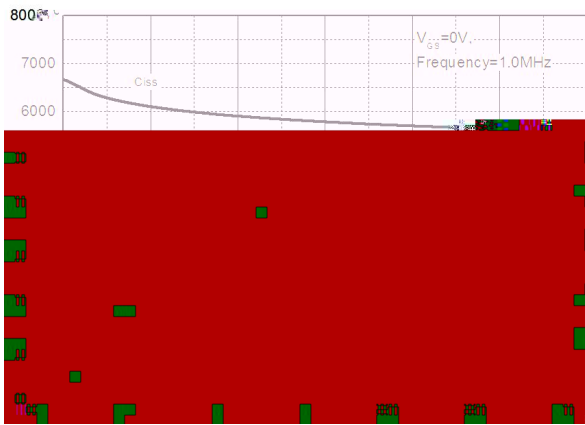
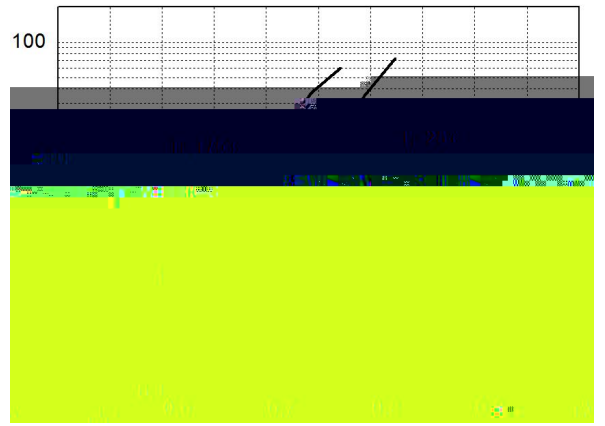
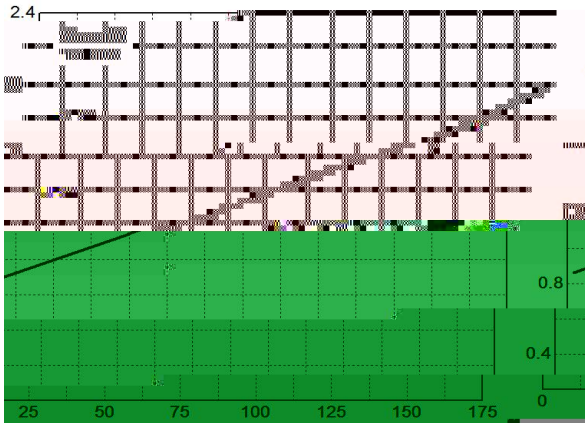

C

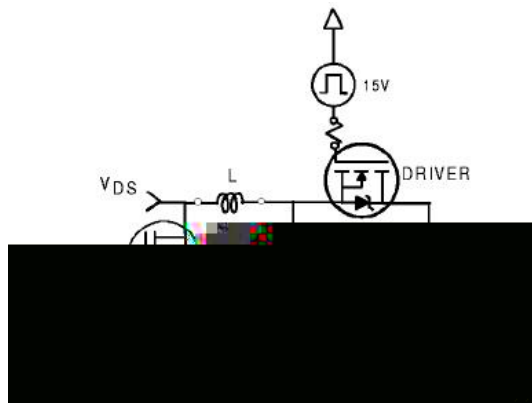

$$E_{AS} = \frac{1}{2} L I_{AS}^2$$

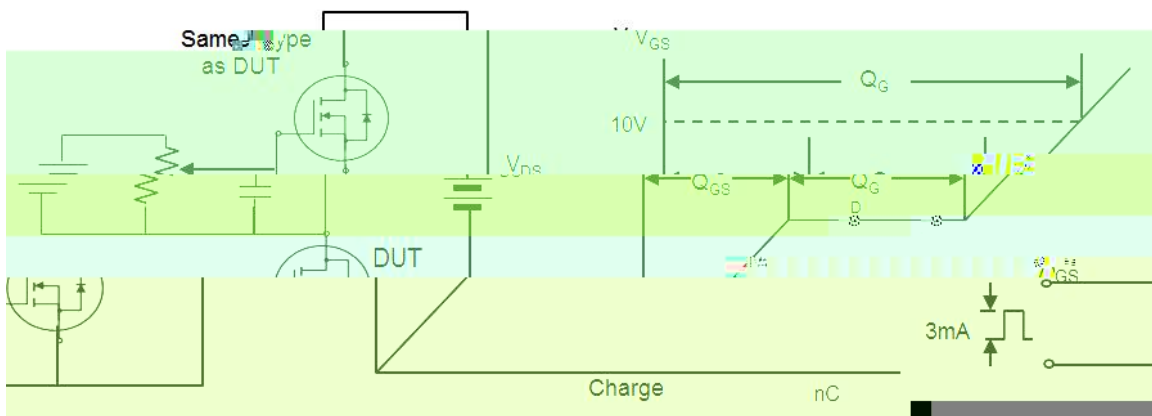
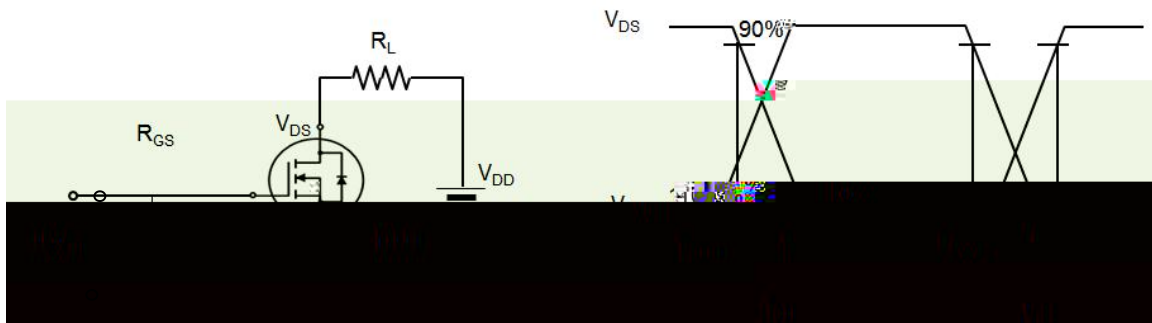
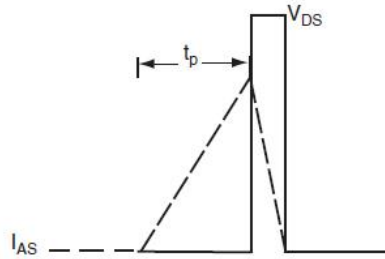

- -

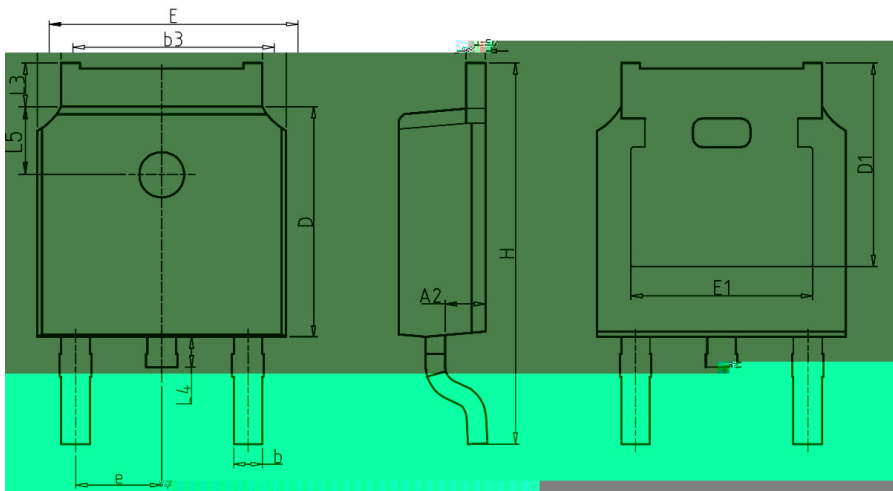

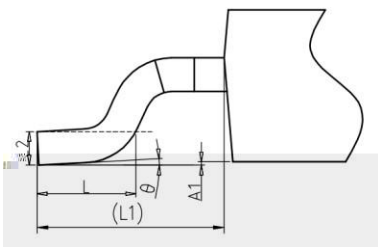



0 0 1

	0	0

0 0- 000

