



N-Channel Enhancement Mode MOSFET

Feature

Pin Description

- 100V/230A
 $R_{DS(ON)}=2.6m$ (typ.) @ $V_{GS} = 10V$
- 100% Avalanche Tested
- Reliable and Rugged
- Lead-Free and Green Devices Available
(RoHS Compliant)

G^DS G^DS

Applications

- Power Switching application
- Uninterruptible Power Supply
- Motor Control

Ordering and Marking Information



Absolute Maximum Ratings

Symbol	Parameter		Rating	Unit
Common Ratings (Tc=25°C Unless Otherwise Noted)				
V _{DSS}	Drain-Source Voltage		100	V
V _{GSS}	Gate-Source Voltage		±20	V
T _J	Maximum Junction Temperature		-55 to 175	°C
T _{STG}	Storage Temperature Range		-55 to 175	°C
I _S	Source Current-Continuous(Body Diode)	Tc=25°C	230	A
Mounted on Large Heat Sink				
I _{DM}	Pulsed Drain Current *	Tc=25°C	610	A
I _D	Continuous Drain Current	Tc=25°C	230	A
		Tc=100°C	162	A
P _D	Maximum Power Dissipation	Tc=25°C	300	W
		Tc=100°C	150	W
R _{JC}	Thermal Resistance, Junction-to-Case		0.5	°C/W
R _{JA}	Thermal Resistance, Junction-to-Ambient **		62	°C/W
E _{AS}	Single Pulsed-Avalanche Energy ***	L=0.3mH	980.7	mJ

Note: * Repetitive rating pulse width limited by max. junction temperature.
 ** Surface mounted on FR-4 board.
 *** Limited by T_{Jmax}, starting T_J=25°C, L = 0.3mH, V_{DS}=80V, V_{GS} =10V.

Electrical Characteristics(Tc =25°C Unless Otherwise Noted)

Symbol	Parameter	Test Conditions	HYG028N10NS1			Unit
			Min	Typ.	Max	
Static Characteristics						
BV _{DSS}	Drain-Source Breakdown Voltage	V _{GS} =0V, I _{DS} =250μA	100	-	-	V
I _{DSS}	Drain-to-Source Leakage Current	V _{DS} =100V, V _{GS} =0V	-	-	1.0	μA
		T _J =125°C	-	-	50	μA
V _{GS(th)}	Gate Threshold Voltage	V _{DS} =V _{GS} , I _{DS} =250μA	2	3	4	V
I _{GSS}	Gate-Source Leakage Current	V _{GS} = %				



Electrical Characteristics (Cont.) (Tc =25°C Unless Otherwise Noted)

Symbol	Parameter	Test Conditions	HYG028N10NS1			Unit
			Min	Typ.	Max	
Dynamic Characteristics						
R _G	Gate Resistance	V _{GS} =0V, V _{DS} =0V, F=1MHz	-	2.8	-	
C _{iss}	Input Capacitance	V _{GS} =0V, V _{DS} =25V, Frequency=1.0MHz	-	10320	-	pF
C _{oss}	Output Capacitance		-	3454	-	
C _{rss}	Reverse Transfer Capacitance		-	242	-	
t _{d(ON)}	Turn-on Delay Time	V _{DD} =50V, R _G =2.5 , I _{DS} =50A, V _{GS} =10V	-	27.3	-	ns
T _r	Turn-on Rise Time		-	103.7	-	
t _{d(OFF)}	Turn-off Delay Time		-	92.8	-	
T _f	Turn-off Fall Time		-	100.8	-	
Gate Charge Characteristics						
Q _g	Total Gate Charge	V _{DS} =80V, V _{GS} =10V I _D =50A	-	176	-	nC
Q _{gs}	Gate-Source Charge		-	56	-	
Q _{gd}	Gate-Drain Charge		-	48	-	

Note: *Pulse test pulse width 300us duty cycle 2%



Typical Operating Characteristics

Figure 1: Power Dissipation



Figure 2: Drain Current

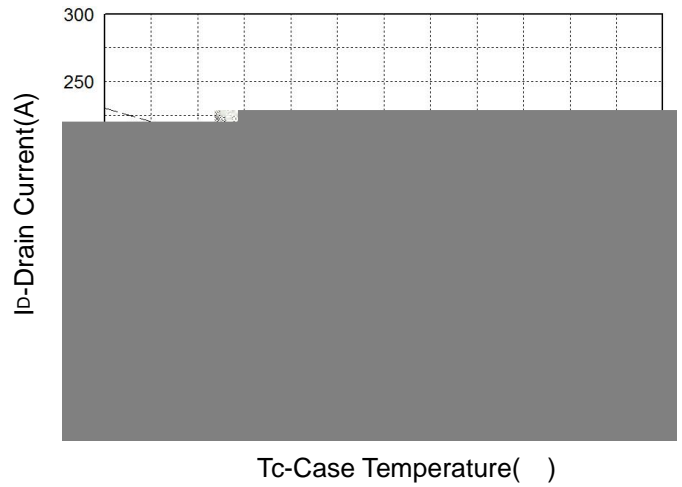

Figure 3: Safe Operation Area

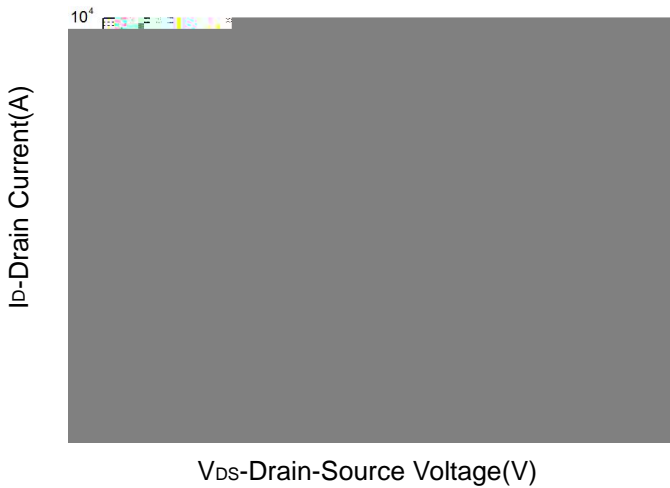

Figure 4: Thermal Transient Impedance

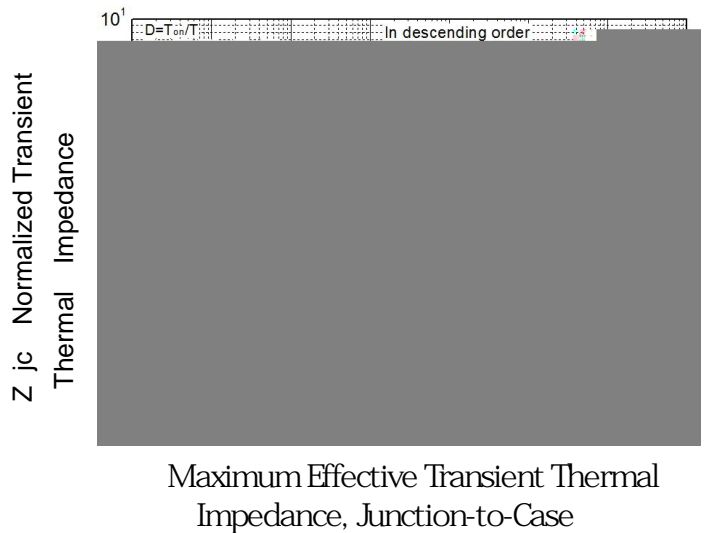

Figure 5: Output Characteristics

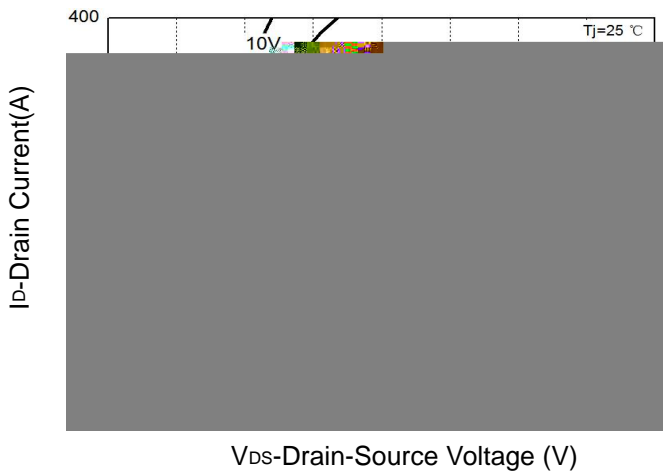
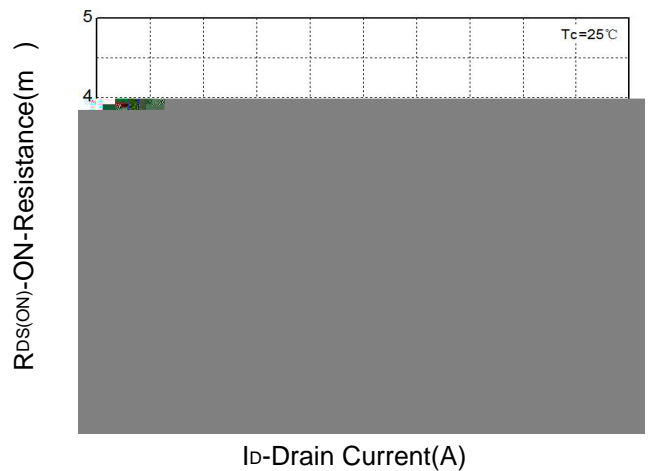

Figure 6: Drain-Source On Resistance





Typical Operating Characteristics(Cont.)

Figure 7: On-Resistance vs. Temperature

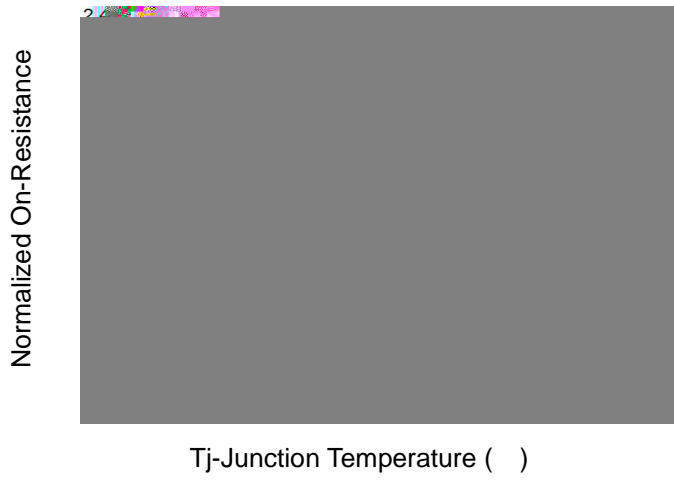

Figure 8: Source-Drain Diode Forward

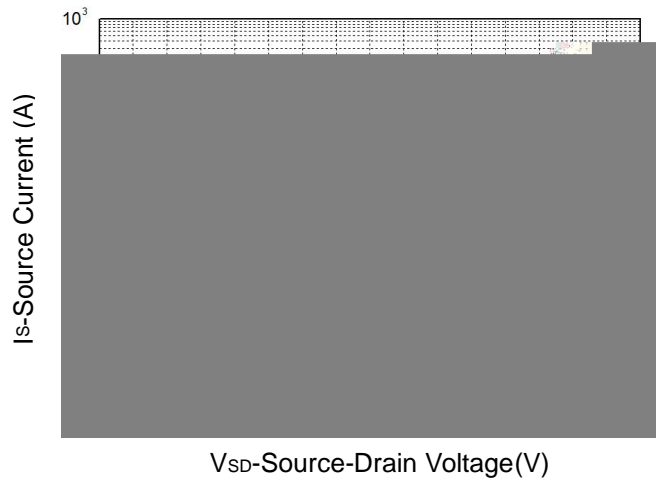

Figure 9: Capacitance Characteristics

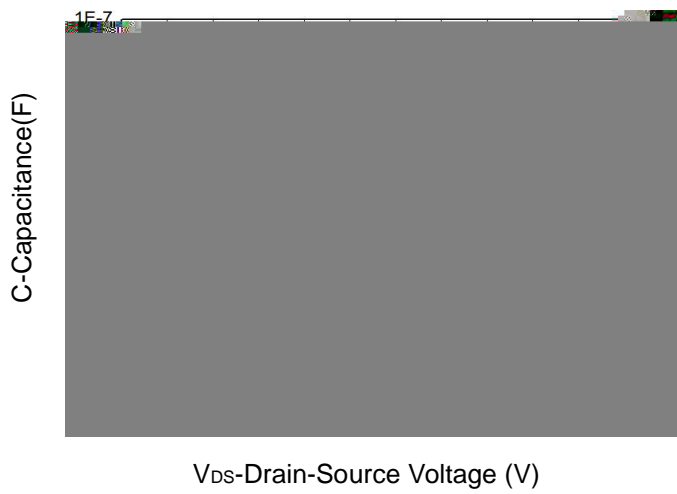
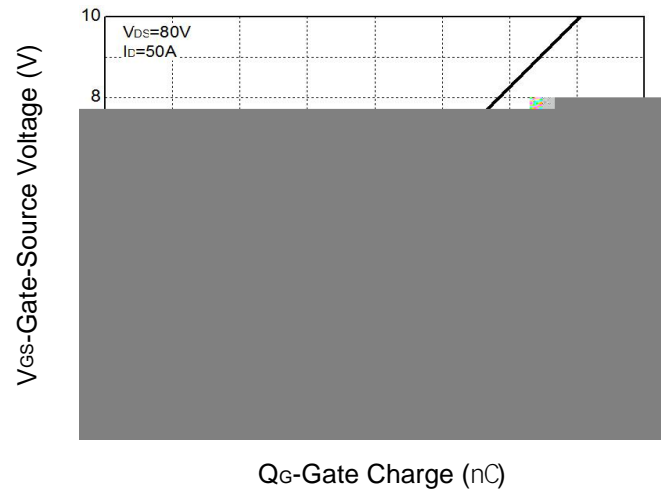
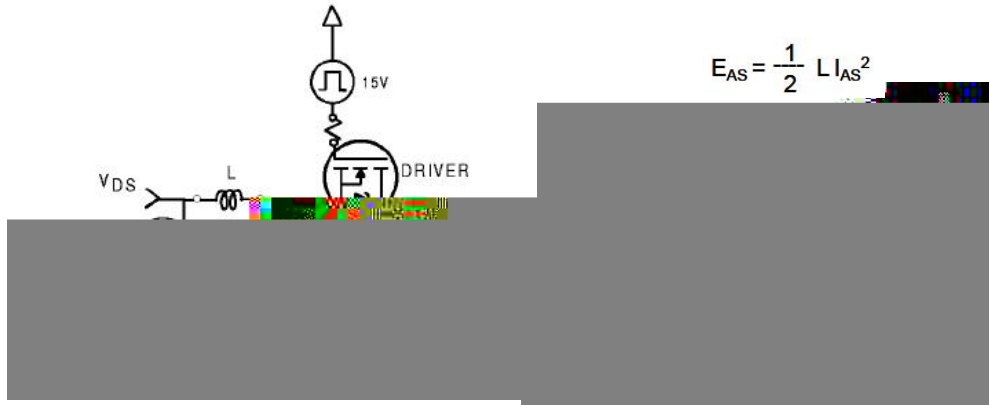

Figure 10: Gate Charge Characteristics





Avalanche Test Circuit



Switching Time Test Circuit

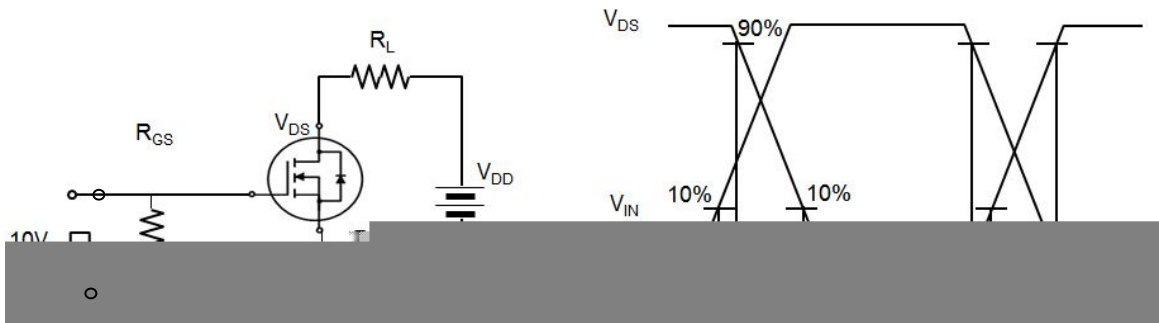

Gate Charge Test Circuit

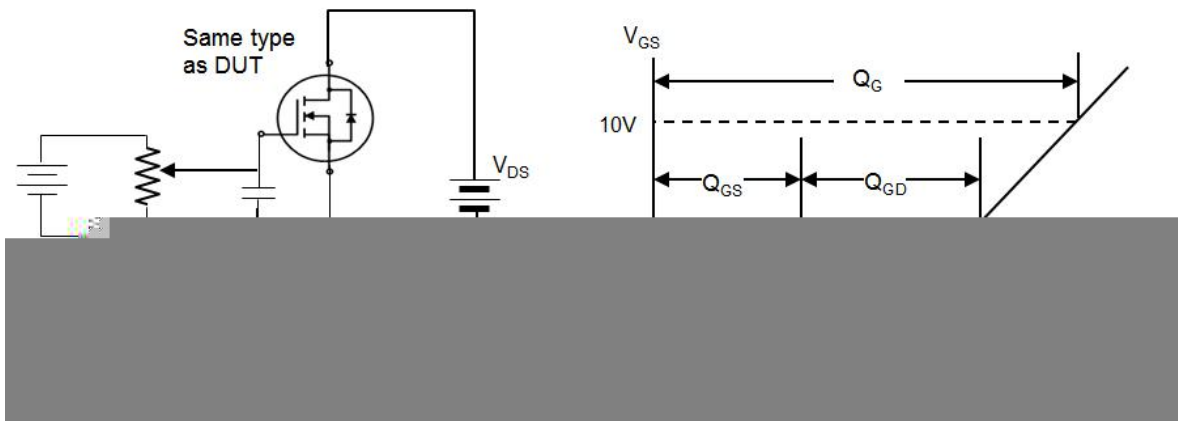



Device Per Unit

Package Type	Unit	Quantity
TO-220FB-3L	Tube	50
TO-263-2L	Tube	50
TO-263-2L	Reel	800

Package Information

TO-220FB-3L

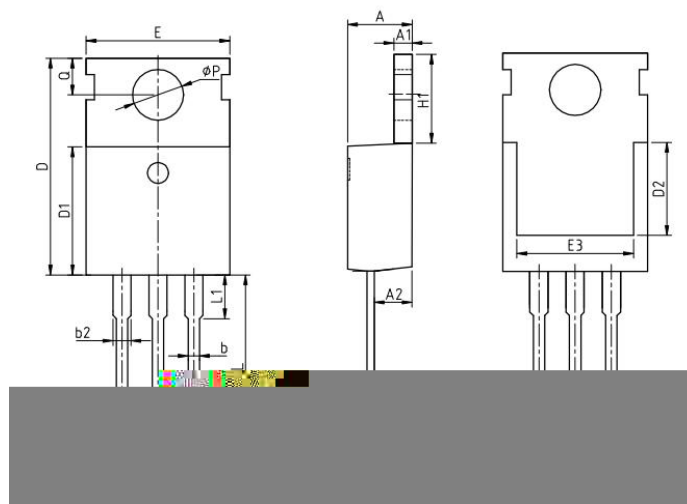

COMMON DIMENSIONS

SYMBOL	mm		
	MIN	NOM	MAX
A	4.37	4.57	4.77
A1	1.25	1.30	1.45
A2	2.20	2.40	2.60
b	0.70	0.80	0.95
b2	1.17	1.27	1.47
c	0.40	0.50	0.65
D	15.10	15.60	16.10
D1	8.80	9.10	9.40
D2	5.50	-	-
E	9.70	10.00	10.30
E3	7.00	-	-
e	2.54 BSC		
e1	5.08 BSC		
H1	6.25	6.50	6.85
L	12.75	13.50	13.80
L1	-	3.10	3.40
P	3.40	3.60	3.80
Q	2.60	2.80	3.00



Package Information

TO-263-2L

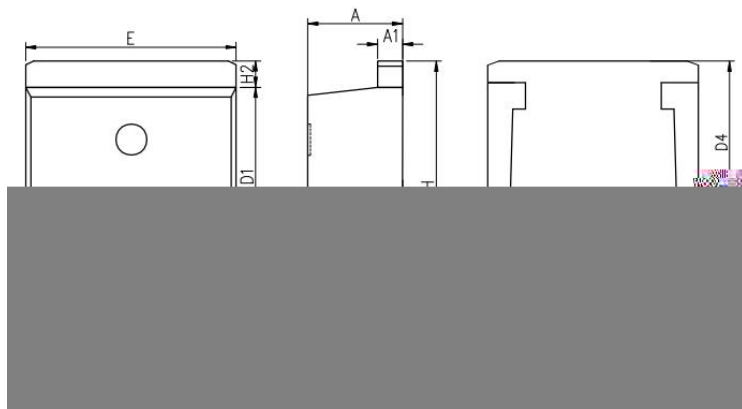

COMMON DIMENSIONS

SYMBOL	mm		
	MIN	NOM	MAX
A	4.37	4.57	4.77
A1	1.22	1.27	1.42
A2	2.49	2.69	2.89
A3	0	0.13	0.25
b	0.7	0.81	0.96
b1	1.17	1.27	1.47
c	0.3	0.38	0.53
D1	8.5	8.7	8.9
D4	6.6	-	-
E	9.86	10.16	10.36
E5	7.06	-	-
e	2.54 BSC		
H	14.7	15.1	15.5
H2	1.07	1.27	1.47
L	2	2.3	2.6
L1	1.4	1.55	1.7
L4	0.25 BSC		
	0°	5°	9°



Classification Profile

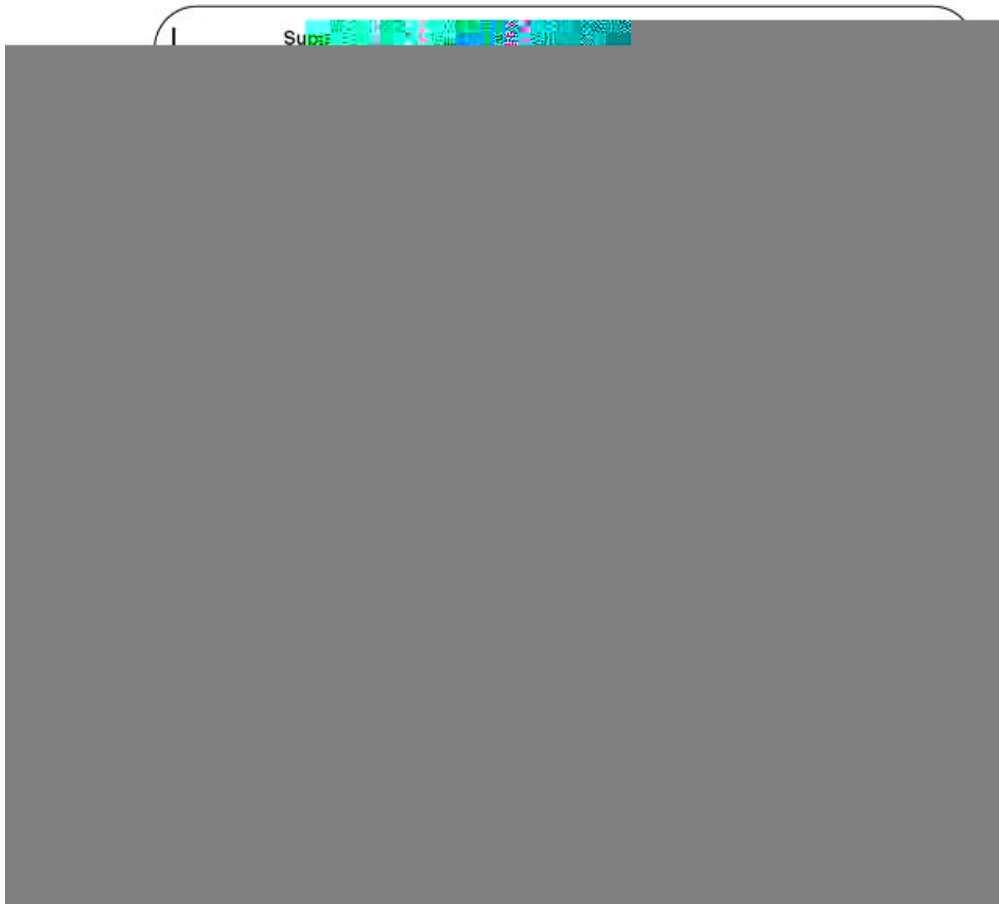

Classification Reflow Profiles

Profile Feature	Sn-Pb Eutectic Assembly	Pb-Free Assembly
Preheat & Soak		
Temperature min (T_{smin})	100 °C	150 °C
Temperature max (T_{smax})	150 °C	200 °C
Time (T_{smin} to T_{smax}) (t_s)	60-120 seconds	60-120 seconds
Average ramp-up rate (T_{smax} to T_P)	3 °C/second max.	3°C/second max.
Liquidous temperature (T_L)	183 °C	217 °C
Time at liquidous (t_L)	60-150 seconds	60-150 seconds
Peak package body Temperature (T_P)*	See Classification Temp in table 1	See Classification Temp in table 2
Time (t_P)** within 5°C of the specified classification temperature (T_c)	20** seconds	30** seconds
Average ramp-down rate (T_P to T_{smax})	6 °C/second max.	6 °C/second max.
Time 25°C to peak temperature	6 minutes max.	8 minutes max.
*Tolerance for peak profile Temperature (T_P) is defined as a supplier minimum and a user maximum.		
** Tolerance for time at peak profile temperature (t_P) is defined as a supplier minimum and a user maximum.		



Table 1. SnPb Eutectic Process – Classification Temperatures (Tc)

Package Thickness	Volume mm ³ <350	Volume mm ³ 350
2.5 mm	235 °C	220 °C
2.5 mm	220 °C	220 °C

Table 2. Pb-free Process – Classification Temperatures (Tc)

Package Thickness	Volume mm ³ <350	Volume mm ³ 350-2000	Volume mm ³ 2000
<1.6 mm	260 °C	260 °C	260 °C
1.6 mm – 2.5 mm	260 °C	250 °C	245 °C
2.5 mm	250 °C	245 °C	245 °C

Reliability Test Program

Test item	Method	Description
-----------	--------	-------------