

N-Channel Enhancement Mode MOSFET

Feature

- 80V/90A
 $R_{DS(ON)} = 7m\Omega(\text{typ.}) @ V_{GS} = 10V$
- 100% Avalanche Tested
- Reliable and Rugged
- Lead- Free Devices Available (RoHS Compliant)

Applications

- Switching application
- Power management for inverter systems

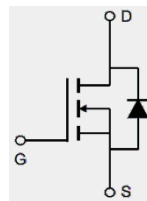





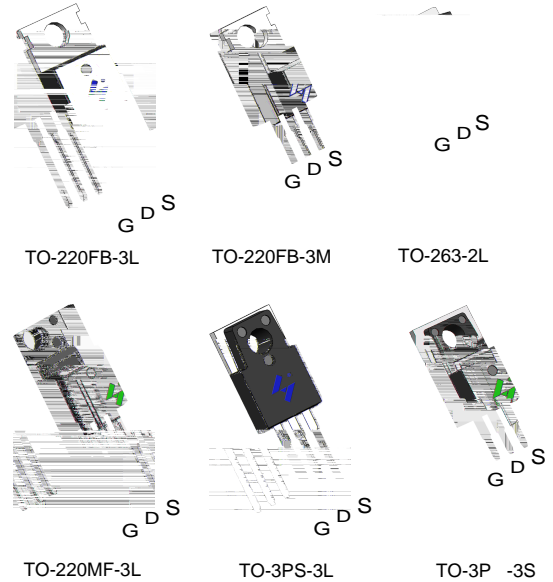

N-Channel MOSFET

Pin Description



Ordering and Marking Information

 P HY1908 YYXXJWW G	 M HY1908 YYXXJWW G	 B HY1908 YYXXJWW G	Package Code P :TO-220FB-3L M:TO-220FB-3S B:TO-263-2L MF:TO-220MF-3L PS:TO-3PS-3L PM:TO-3PM-3S
 MF HY1908 YYXXJWW G	 PS HY1908 YYXXJWW G	 PM HY1908 YYXXJWW G	Date Code Assembly Material YYXX WW G:Lead Free

Note: HUAYI lead-free products contain molding compounds/die attach materials and 100% matte tin plate Termination finish; which are fully compliant with RoHS. HUAYI lead-free products meet or exceed the lead-free requirements of IPC/JEDEC J-STD-020 for MSL classification at lead-free peak reflow temperature. HUAYI defines "Green" to mean lead-free (RoHS compliant) and halogen free (Br or Cl does not exceed 900ppm by weight in homogeneous material and total of Br and Cl does not exceed 1500ppm by weight).

HUAYI reserves the right to make changes, corrections, enhancements, modifications, and improvements to this product and/or to this document at any time without notice.

Absolute Maximum Ratings

Symbol	Parameter		Rating	Unit
Common Ratings (Tc=25°C Unless Otherwise Noted)				
V _{DSS}	Drain-Source Voltage		80	V
V _{GSS}	Gate-Source Voltage		±25	V
T _J	Maximum Junction Temperature		-55 to 175	°C
T _{STG}	Storage Temperature Range		-55 to 175	°C
I _S	Source Current-Continuous(Body Diode)	Tc=25°C	90	A
Mounted on Large Heat Sink				
I _{DM}	Pulsed Drain Current *	Tc=25°C	360**	A
I _D	Continuous Drain Current	Tc=25°C	90	A
		Tc=100°C	64	A
P _D	Maximum Power Dissipation	Tc=25°C	185	W
		Tc=100°C	92	W
R _{θJC}	Thermal Resistance, Junction-to-Case		0.81	°C/W
R _{θJA}	Thermal Resistance, Junction-to-Ambient **		62.5	°C/W
E _{AS}	SinglePulsed-Avalanche Energy ***	L=0.5 mH	416***	mJ

Note: * Repetitive rating pulse width limited by max.junction temperature.

** Surface mounted on 1in2 FR-4 board.

*** Limited by T_{Jmax}, starting T_J=25°C, L = 0.5mH, R_G= 25 , V_{GS}=10V.

Electrical Characteristics(Tc =25°C Unless Otherwise Noted)

Symbol	Parameter	Test Conditions	HY1908			Unit
			Min	Typ.	Max	
Static Characteristics						
BV _{DSS}	Drain-Source Breakdown Voltage	V _{GS} =0V, I _{DS} = 250μA	80	-	-	V
I _{DSS}	Drain-to-Source Leakage Current	V _{DS} = 80V, V _{GS} =0V	-	-	1	μA
		T _J =125°C	-	-	50	μA
V _{GS(th)}	Gate Threshold Voltage	V _{DS} =V _{GS} , I _{DS} = 250μA	2	3	4	V
I _{GSS}	Gate-Source Leakage Current	V _{GS} = 25V, V _{DS} =0V	-	-	±100	nA
R _{DS(ON)}	Drain-Source On-State Resistance	V _{GS} = 10V, I _{DS} = 45A	-	7	9	m
Diode Characteristics						
V _{SD}	Diode Forward Voltage	I _{SD} =45A, V _{GS} =0V	-	0.8	1	V
t _{rr}	Reverse Recovery Time	I _{SD} =45A, dI _{SD} /dt=100A/μs	-	60	-	ns
Q _{rr}	Reverse Recovery Charge		-	125	-	nC

Electrical Characteristics (Cont.) (Tc =25°C Unless Otherwise Noted)

Symbol	Parameter	Test Conditions	HY1908			Unit
			Min	Typ.	Max	
Dynamic Characteristics						
R _G	Gate Resistance	V _{GS} =0V, V _{DS} =0V, F=1MHz	-	3	-	
C _{iss}	Input Capacitance	V _{GS} =0V, V _{DS} = 25V, Frequency=1.0MHz	-	3800	-	pF
C _{oss}	Output Capacitance		-	389	-	
C _{rss}	Reverse Transfer Capacitance		-	250	-	
t _{d(ON)}	Turn-on Delay Time	V _{DD} = 40V, R _G =6Ω, I _{DS} = 45A, V _{GS} = 10V	-	25	45-	ns
T _r	Turn-on Rise Time		-	42	75	
t _{d(OFF)}	Turn-off Delay Time		-	62	100	
T _f	Turn-off Fall Time			19	30	
Gate Charge Characteristics						
Q _g	Total Gate Charge	V _{DS} = 64V, V _{GS} = 10V, I _{DS} = 45A	-	86	-	nC
Q _{gs}	Gate-Source Charge		-	16	-	
Q _{gd}	Gate-Drain Charge		-	28	-	

Note: *Pulse test pulse width ≤ 300us duty cycle ≤ 2%

HY1908P/M/B/MF/PS/PM

Typical Operating Characteristics

Figure 1: Power Dissipation

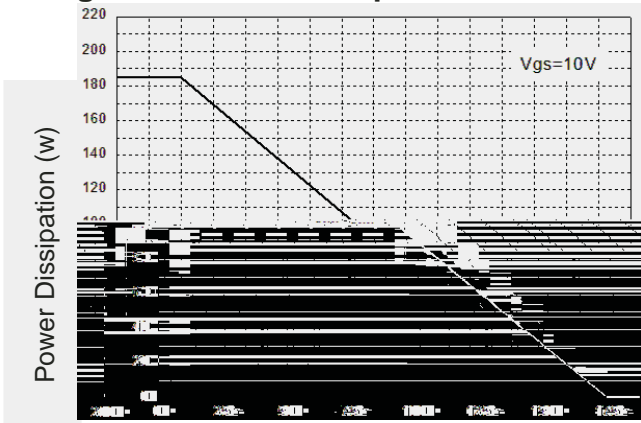

Tc-Case Temperature()

Figure 2: Drain Current

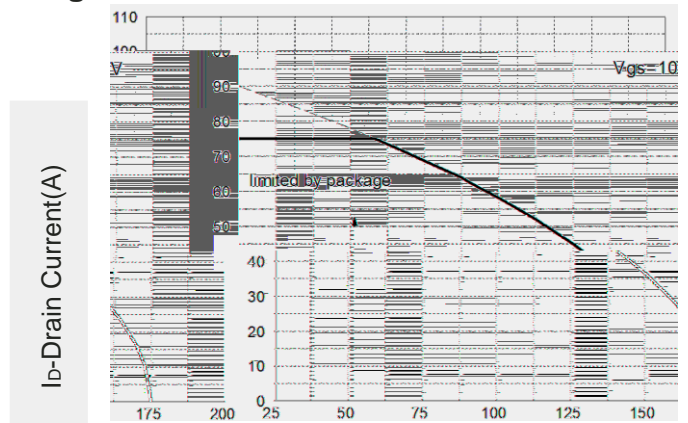

Tc-Case Temperature()

Figure 3: Safe Operation Area

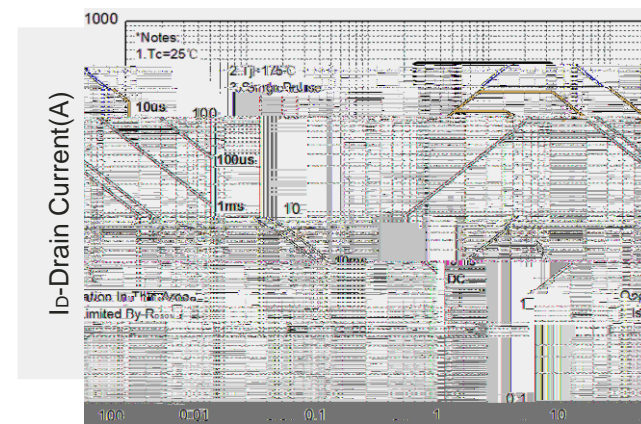

VDs-Drain-Source Voltage(V)

Figure 4: Thermal Transient Impedance

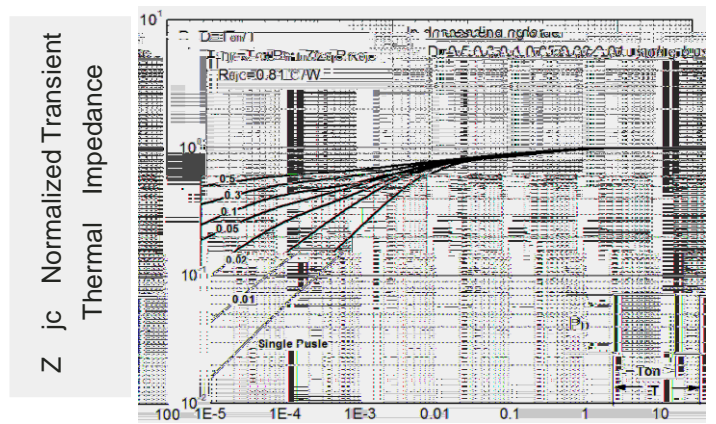

Z_{jc} Normalized Transient Thermal Impedance

Figure 5: Output Characteristics

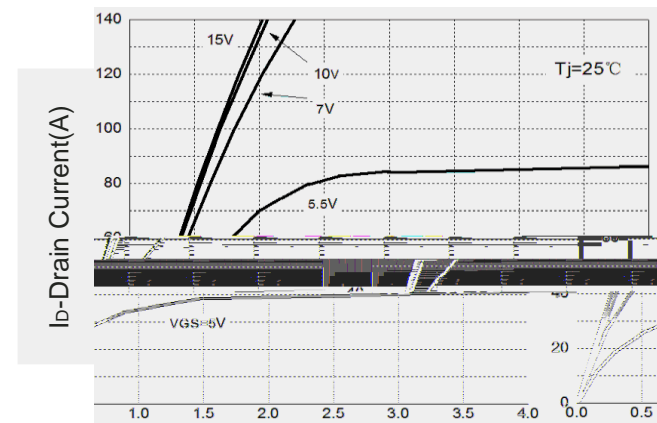

VDs-Drain-Source Voltage (V)

Figure 6: Drain-Source On Resistance

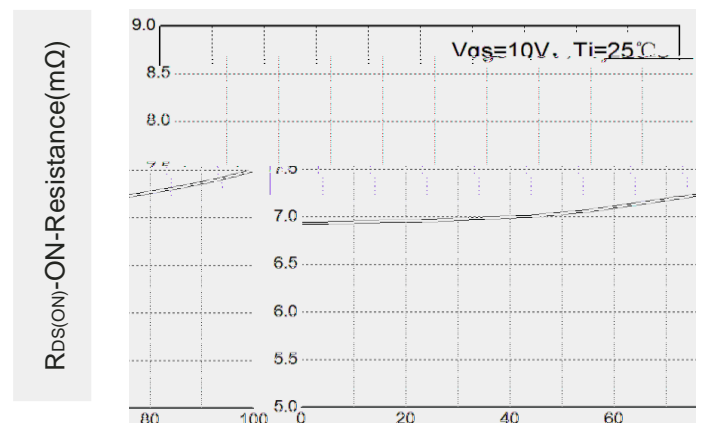

Id-Drain Current(A)

Avalanche Test Circuit

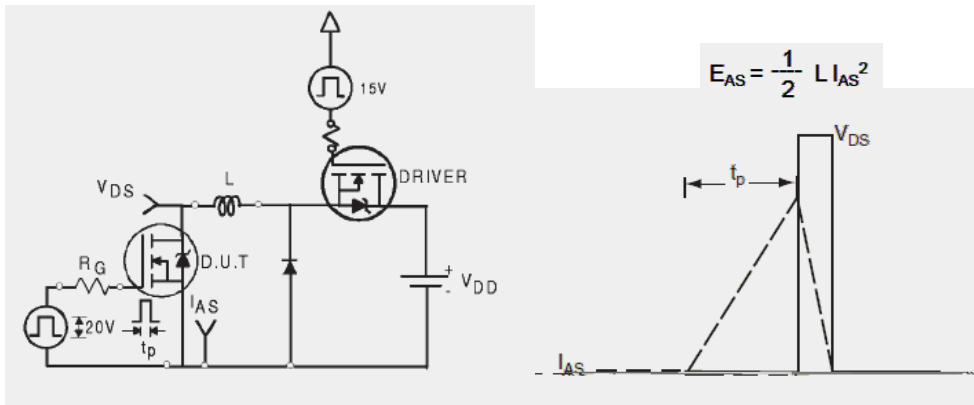

Switching Time Test Circuit

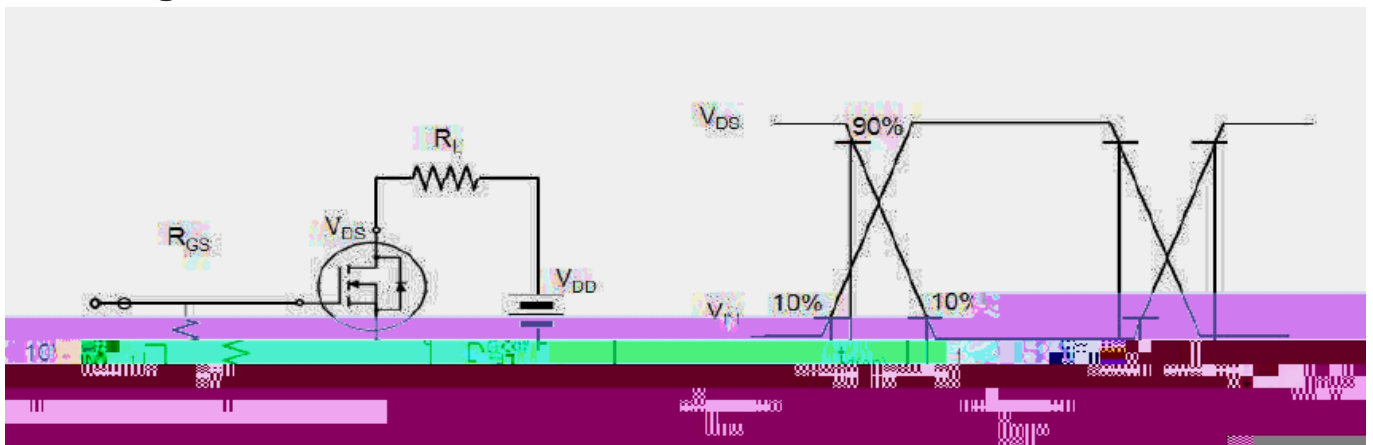

Gate Charge Test Circuit

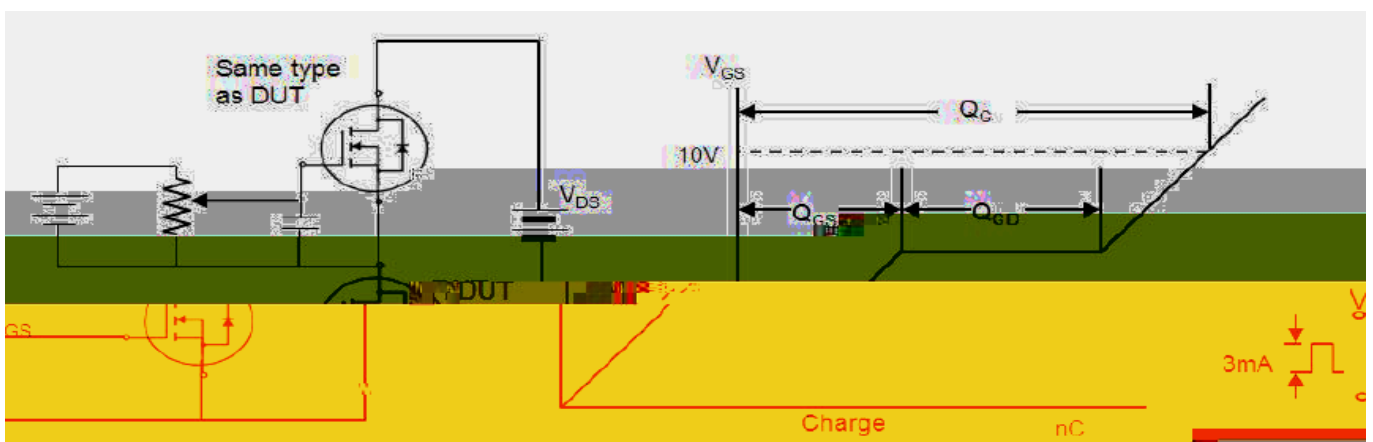

Device Per Unit

Package Type	Unit	Quantity
TO-220FB-3L	Tube	50

Package Information

TO-220FB-3L

COMMON DIMENSIONS

SYMBOL	mm		
	MIN	NOM	MAX
A	4.37	4.57	4.77

Device Per Unit

Package Type	Unit	Quantity
TO-220FB-3S	Tube	50

Package Information

TO-220FB-3S

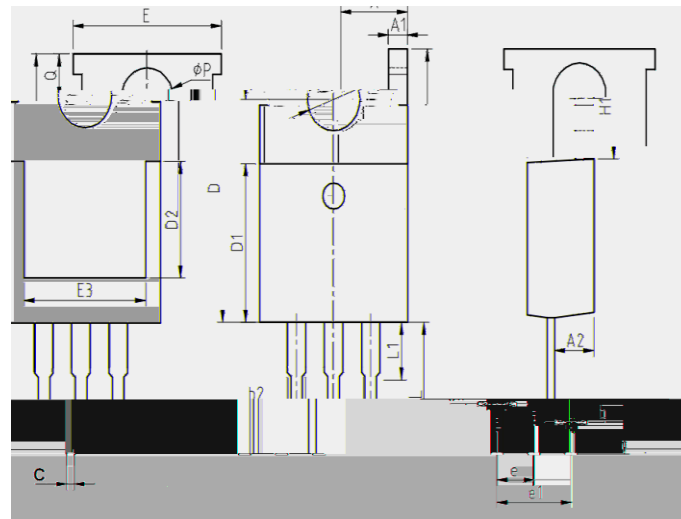

COMMON DIMENSIONS

SYMBOL	mm		
	MIN	NOM	MAX
A	4.37	4.57	4.77
A1	1.25	1.30	1.45
A2	2.20	2.40	2.60
b	0.70	0.80	0.95
b2	1.17	1.27	1.47
c	0.40	0.50	0.65
D	15.10	15.60	16.10
D1	8.10	9.10	9.40
D2	5.50	-	-
E	9.70	10.00	10.30
E3	7.00	-	-
e	2.54 BSC		
e1	5.08 BSC		
H1	6.25	6.50	6.85
L	6.80	7.00	7.20
L1	-	3.10	3.40
ΦP	3.40	3.60	3.80
Q	2.60	2.80	3.00

Device Per Unit

Package Type	Unit	Quantity
TO-263-2L	Reel	50

Package Information

TO-263-2L

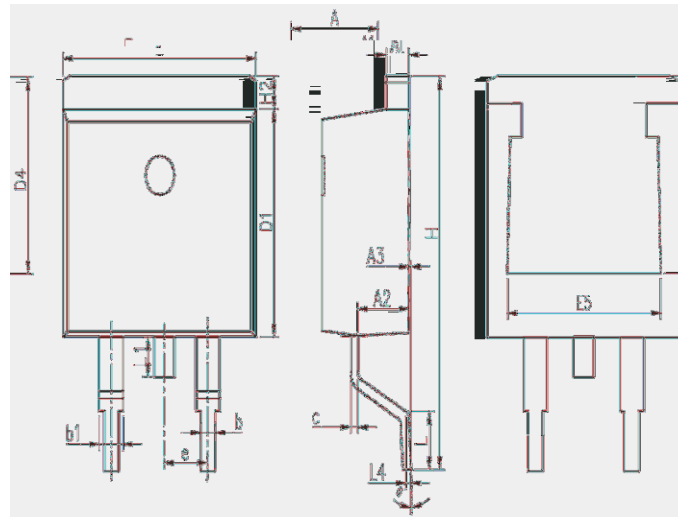

COMMON DIMENSIONS

SYMBOL	mm		
	MIN	NOM	MAX
A	4.37	4.57	4.77
A1	1.22	1.27	1.42
A2	2.49	2.69	2.89
A3	0	0.13	0.25
b	0.7	0.81	0.96
b1	1.17	1.27	1.47
c	0.3	0.38	0.53
D1	8.5	8.7	8.9
D4	6.6	-	-
E	9.86	10.16	10.36
E5	7.06	-	-
e	2.54 BSC		
H	14.7	15.1	15.5
H2	1.07	1.27	1.47
L	2	2.3	2.6
L1	1.4	1.55	1.7
L4	0.25 BSC		
θ	0°	5°	9°

Device Per Unit

Package Type	Unit	Quantity
TO-220MF-3L	Tube	50

Package Information

TO-220MF-3L

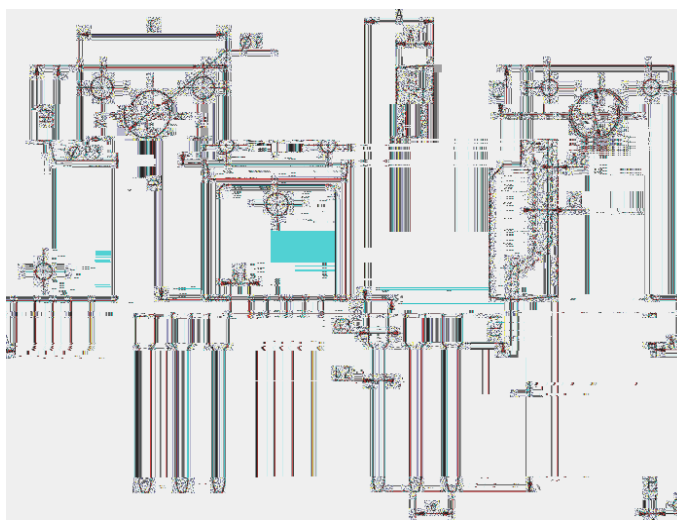

COMMON DIMENSIONS

SYMBOL	mm		
	MIN	NOM	MAX
E	9.96	10.16	10.36
A	4.50	4.70	4.90
A1	2.34	2.54	2.74
A2	0.30	0.45	0.60
A4	2.56	2.76	2.96
c	0.40	0.50	0.65
c1	1.20	1.30	1.35
D	15.57	15.87	16.17
H1	6.70REF		
e	2.54BSC		
L	12.68	12.98	13.28
L1	2.93	3.03	3.13
ΦP	3.03	3.18	3.38
ΦP3	3.15	3.45	3.65
F3	3.15	3.30	3.45
G3	1.25	1.35	1.55
b1	1.18	1.28	1.43
b2	0.70	0.80	0.95

Device Per Unit

Package Type	Unit	Quantity
TO-3PS-3L	Tube	50

Package Information

TO-3PS-3L

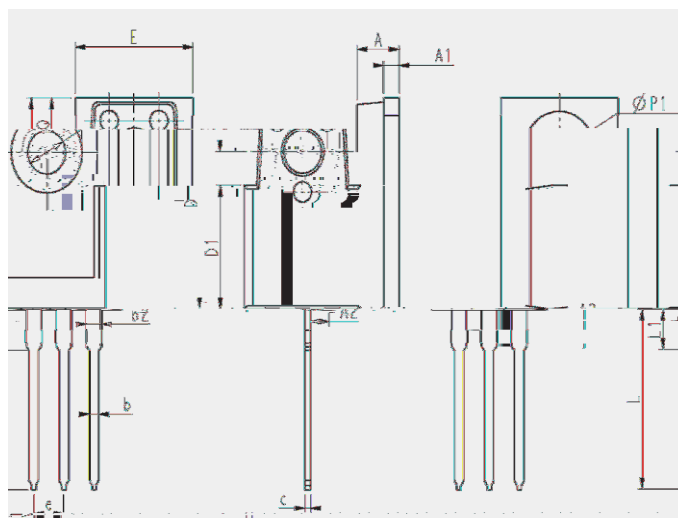

COMMON DIMENSIONS

SYMBOL	mm		
	MIN	NOM	MAX
A	3.36	3.56	3.76
A1	1.25	1.30	1.40
A2	1.39	1.54	1.69
b	0.75	0.80	0.90
b2	1.17	1.27	1.42
c	0.45	0.50	0.60
D	15.45	15.70	15.95
D1	9.00	9.20	9.40
E	9.88	10.00	10.20
e	2.54 BSC		
L	13.20	13.40	13.60
L1	-	3.00	3.30
ΦP1	3.20 REF		
Q	3.88	4.00	4.12

HY1908P/M/B/MF/PS/PM

Device Per Unit

Package Type	Unit	Quantity
TO-3PM-3S	Tube	50

Package Information

TO-3PM-3S

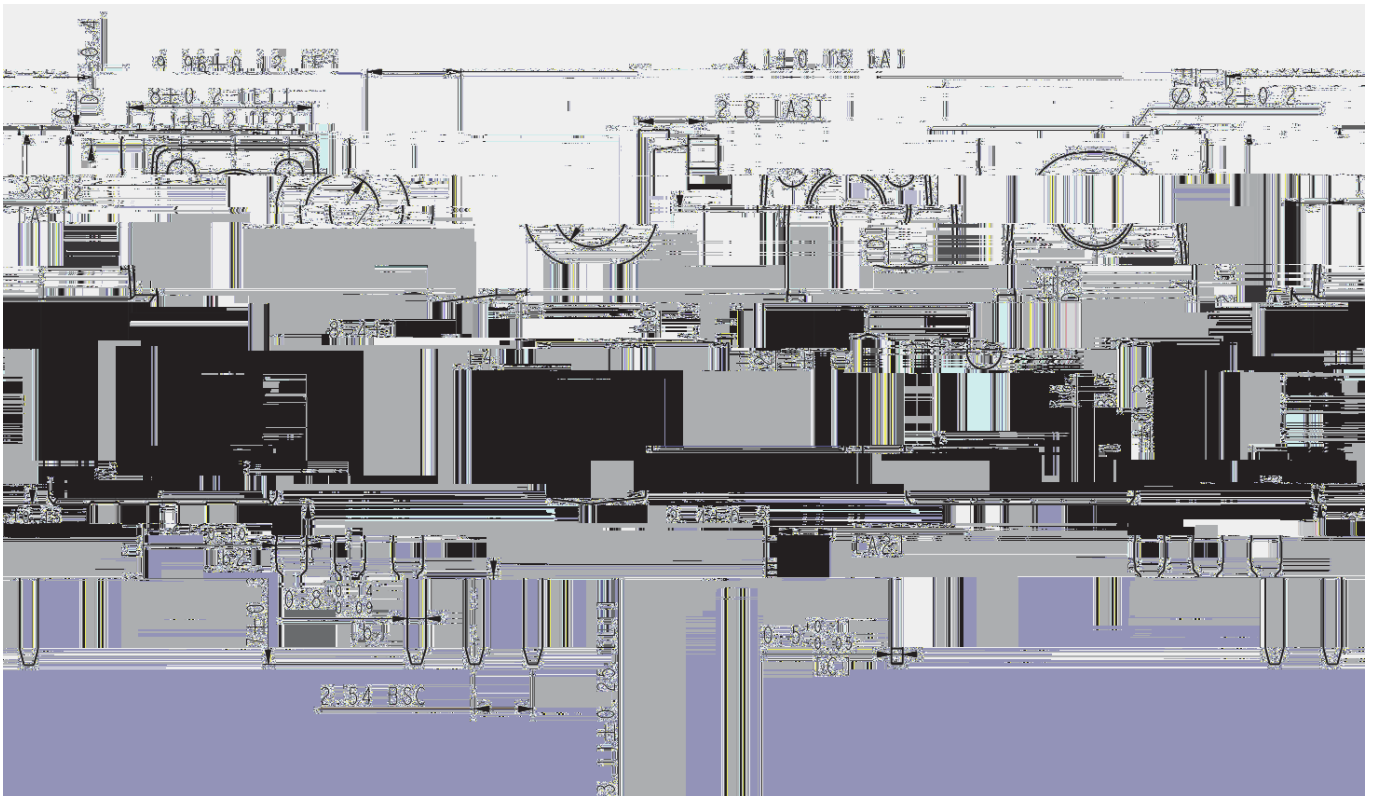

Classification Profile

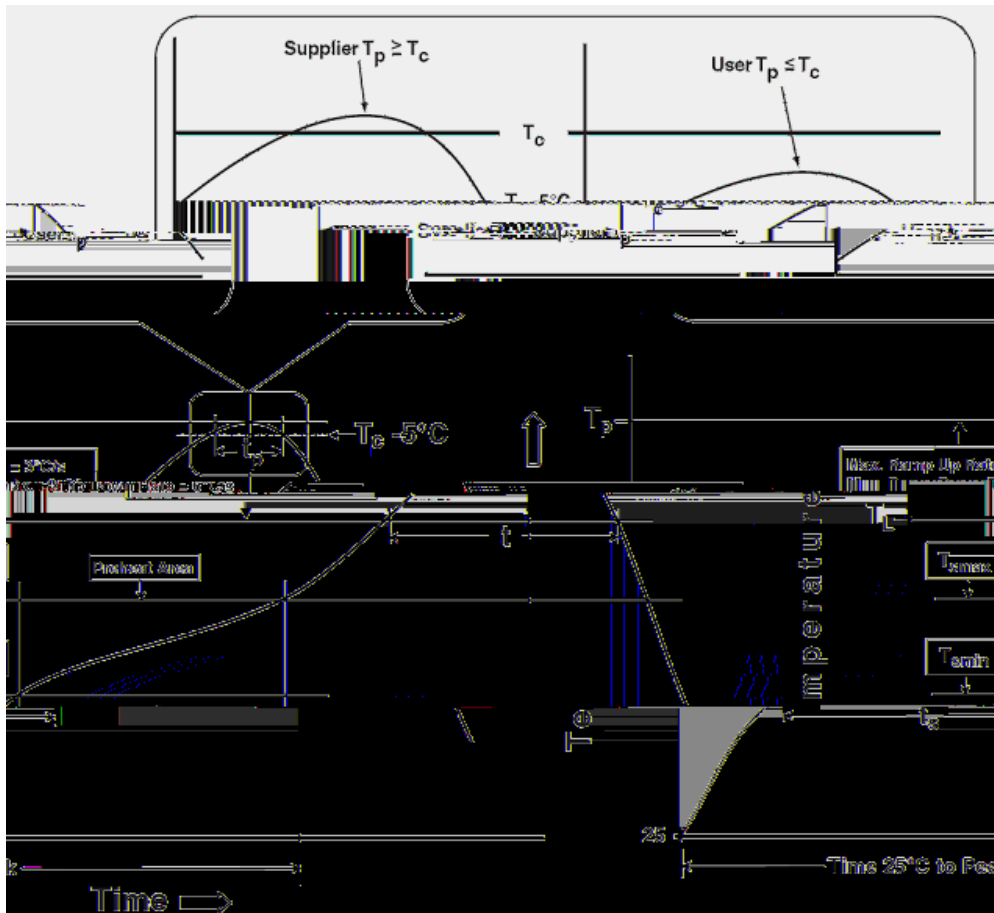

Classification Reflow Profiles

Profile Feature	Sn-Pb Eutectic Assembly	Pb-Free Assembly
Preheat & Soak		
Temperature min (T_{smin})	100 °C	150 °C
Temperature max (T_{smax})	150 °C	200 °C
Time (T_{smin} to T_{smax}) (t_s)	60-120 seconds	60-120 seconds
Average ramp-up rate (T_{smax} to T_P)	3 °C/second max.	3°C/second max.
Liquidous temperature (T_L)	183 °C	217 °C
Time at liquidous (t_L)	60-150 seconds	60-150 seconds
Peak package body Temperature (T_P)*	See Classification Temp in table 1	See Classification Temp in table 2
Time (t_P)** within 5°C of the specified classification temperature (T_c)	20** seconds	30** seconds
Average ramp-down rate (T_P to T_{smax})	6 °C/second max.	6 °C/second max.
Time 25°C to peak temperature	6 minutes max.	8 minutes max.

*Tolerance for peak profile Temperature (T_P) is defined as a supplier minimum and a user maximum.

** Tolerance for time at peak profile temperature (t_P) is defined as a supplier minimum and a user maximum.

Table 1. SnPb Eutectic Process – Classification Temperatures (Tc)

Package Thickness	Volume mm <350	Volume mm 350
2.5 mm	235 °C	220 °C
≥2.5 mm	220 °C	220 °C

Table 2. Pb-free Process – Classification Temperatures (Tc)

Package Thickness	Volume mm <350	Volume mm 350-2000	Volume mm 2000
<1.6 mm	260 °C	260 °C	260 °C
1.6 mm – 2.5 mm	260 °C	250 °C	245 °C
2.5 mm	250 °C	245 °C	245 °C

Reliability Test Program

Test item	Method	Description
SOLDERABILITY		