



•

□

•

• 5 €H

•

0				

, .

			0 0 0 1		
			.		
					m

0 0 0 1

(.)

0 0 0 1

.

□ □

1

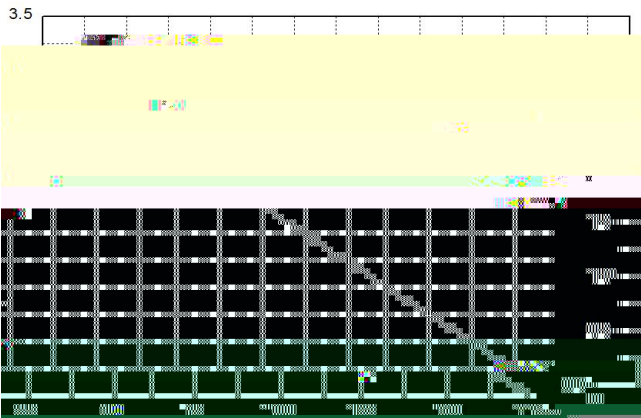

16

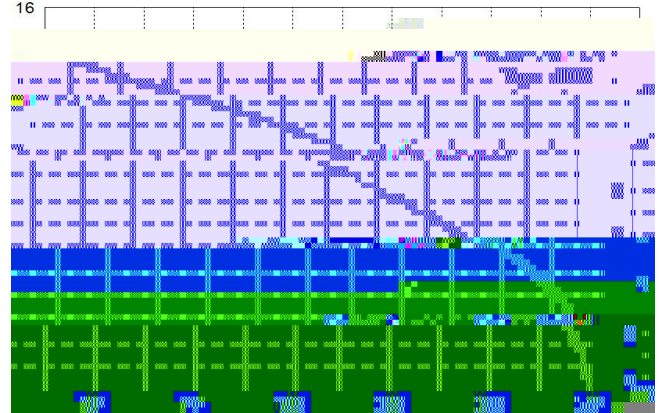

100

*Notes:

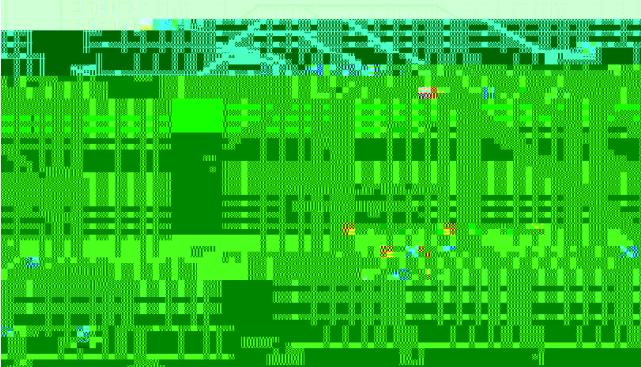

100

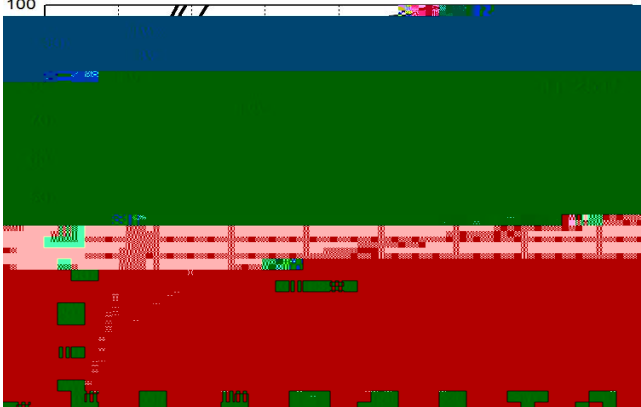

(.)

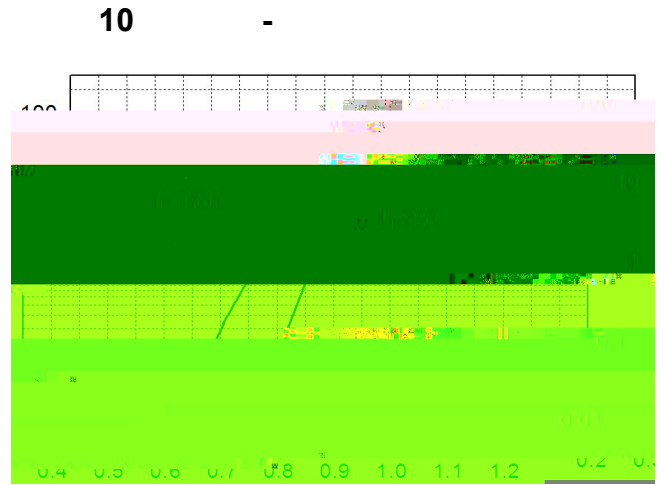
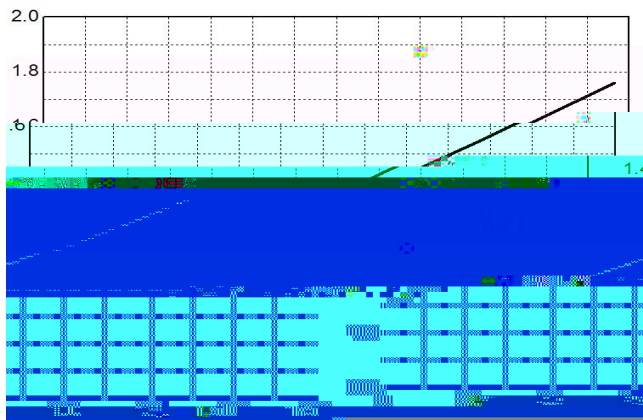

11

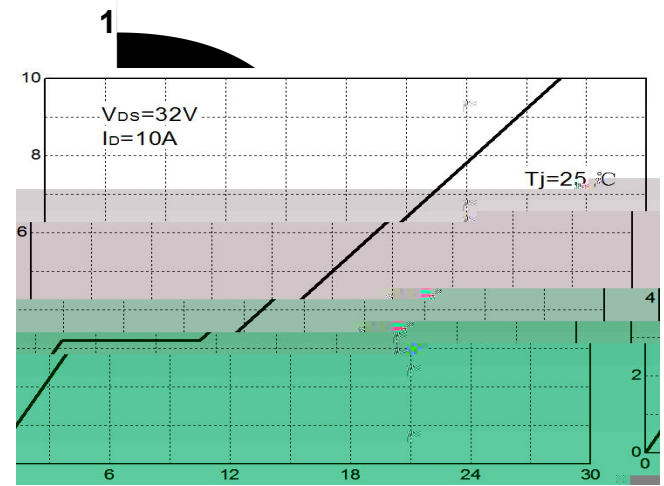
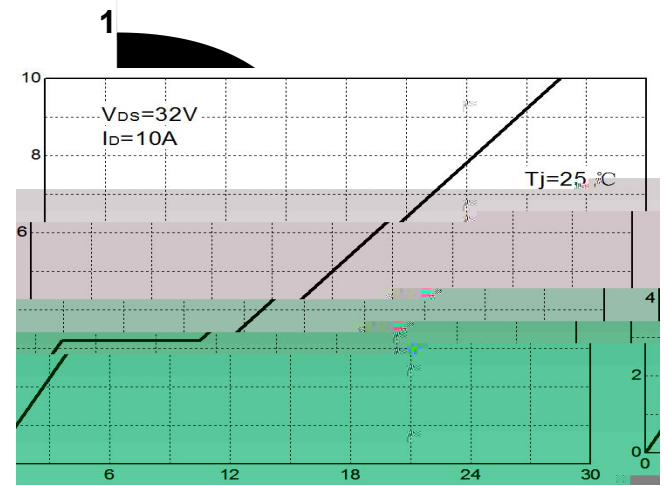
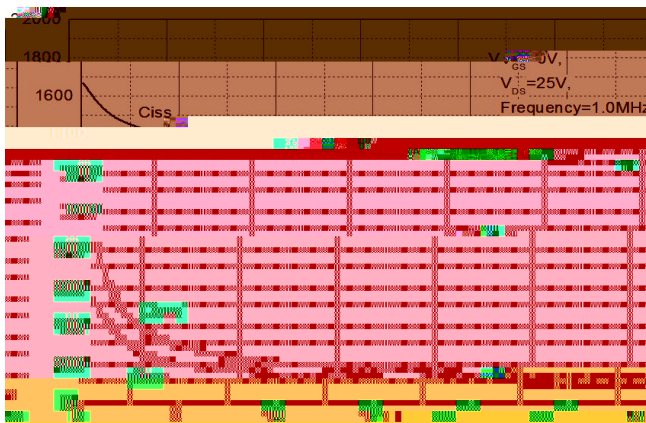

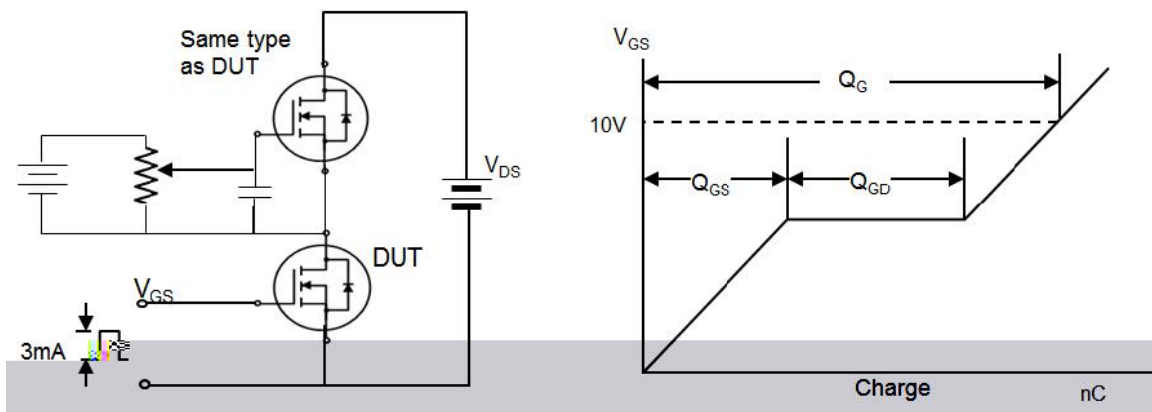
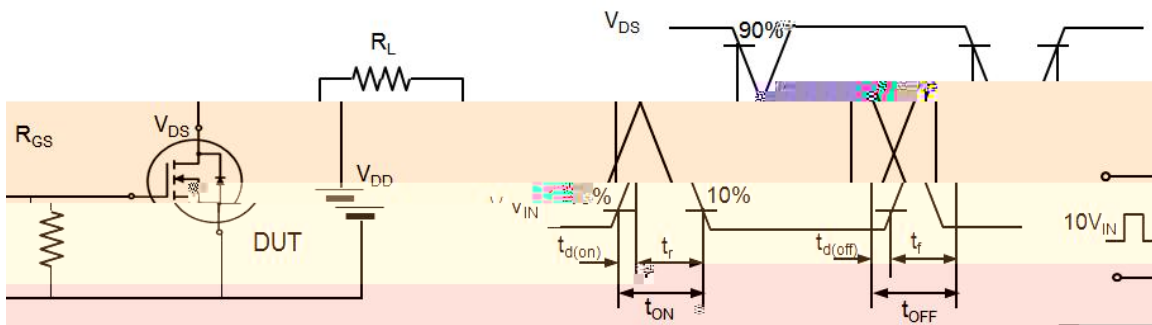
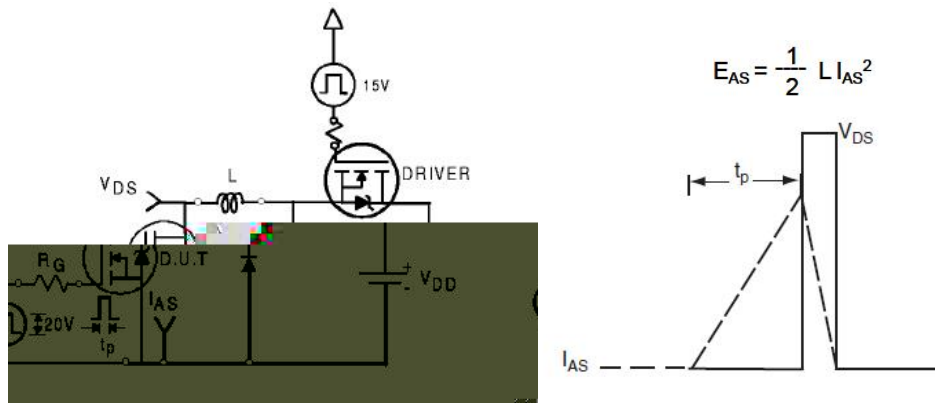

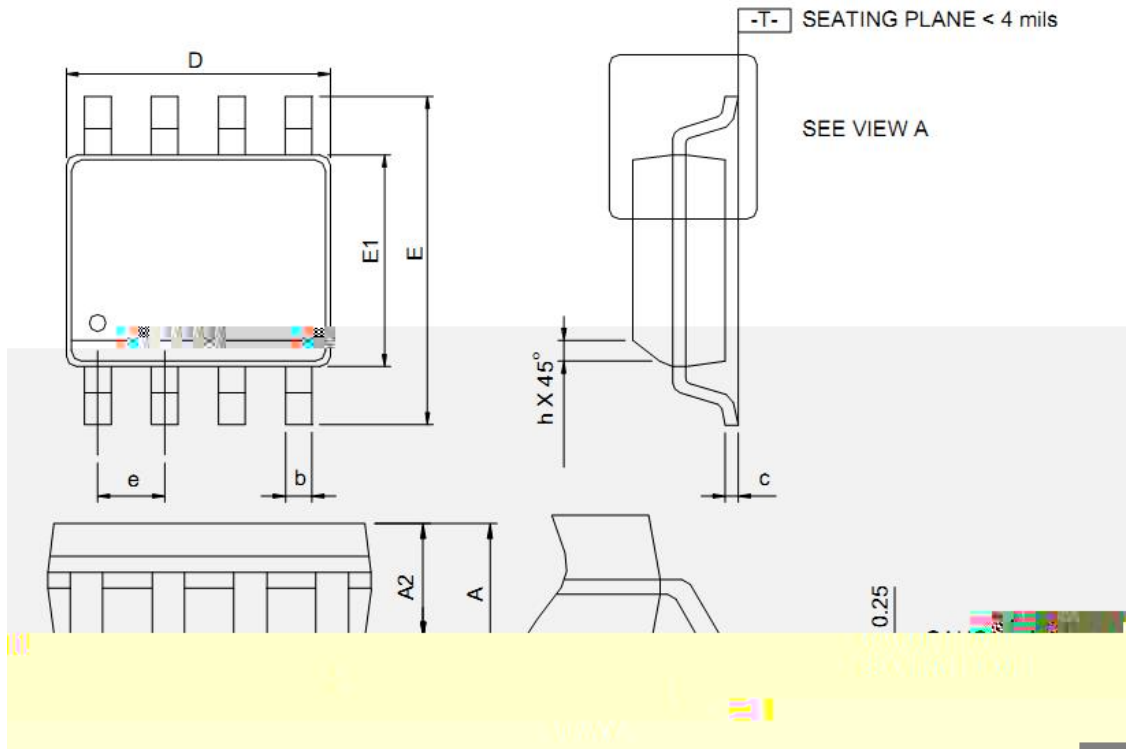

S	SOP-8L				RECOMMENDED LAND PATTERN
	MILLIMETERS		INCHES		
A	MIN.	MAX.	MIN.	MAX.	1.27
1.41	-	1.75	-	0.069	1.27

Color-coded PCB layout diagram showing component placement and dimensions. The layout includes a central component footprint and surrounding pads, with dimensions and values corresponding to the table above.

&

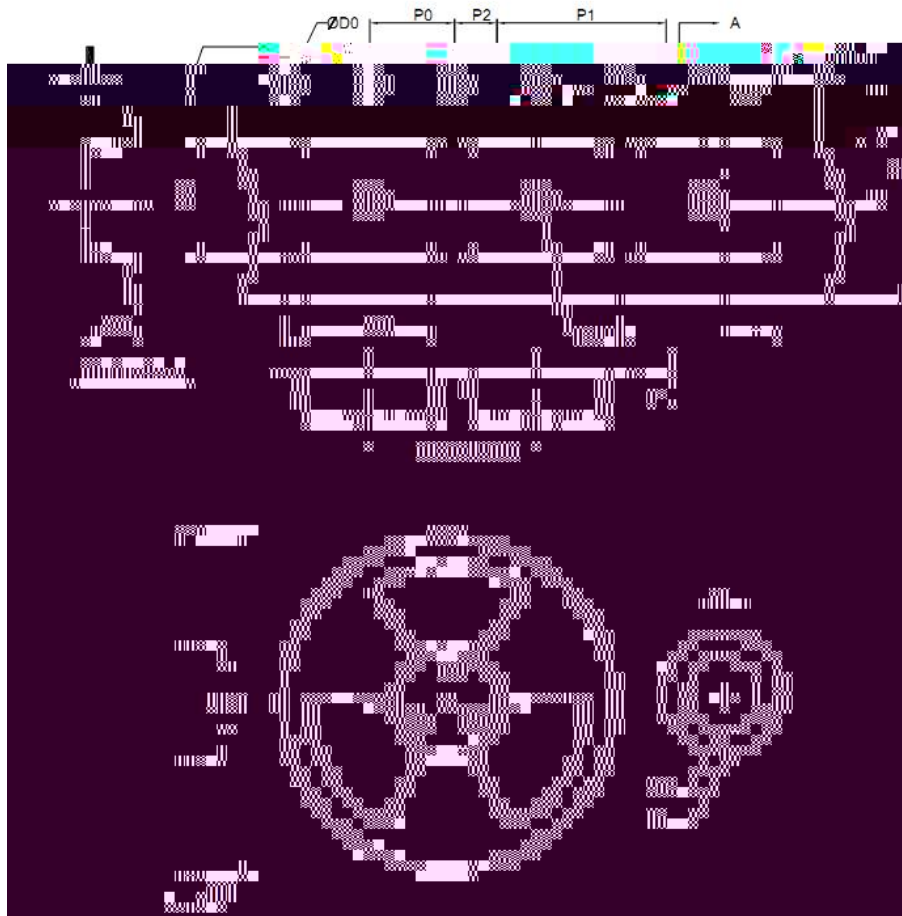

Application	A	H	T1	C	D	W	E1	F	
SOP-8L	330.0 2.00	50 MIN.	12.4+2.00 -0.00	13.0+0.50 -0.20	1.5 MIN.	20.2 MIN.	12.0 0.30	1.75 0.10	5.5 0.05
	P0	P1	P2	D0	D1	T	A0	B0	K0
	4.0 0.10	8.0 0.10	2.0 0.05	1.5+0.10 -0.00	1.5 MIN.	0.6+0.00 -0.40	6.4 0.20	6.2 0.20	2.1 0.20

(mm)

